



The essentials of imaging

KONICA MINOLTA

DiMAGE Xg



E INSTRUCTION MANUAL

BEFORE YOU BEGIN

Thank you for purchasing this product. Please take the time to read through this instruction manual so you can enjoy all the features of your new digital camera.

Check the packing list before using this product. If any items are missing, immediately contact your camera dealer.

DiIMAGE Xg digital camera
Lithium-ion battery NP-200
Lithium-ion battery charger BC-700
Hand strap HS-DG100
SD Memory Card
USB cable USB-500
DiIMAGE Viewer CD-ROM
DiIMAGE Viewer manual
Camera manual
Warranty card

Konica Minolta is a trademark of Konica Minolta Holdings, Inc. DiIMAGE is a trademark of Konica Minolta Camera, Inc. Apple, the Apple logo, Macintosh, Power Macintosh, Mac OS, and the Mac OS logo are registered trademarks of Apple Computer Inc. Microsoft and Windows are registered trademarks of the Microsoft Corporation. The official name of Windows is Microsoft Windows Operating System. Pentium is a registered trademark of the Intel Corporation. Power PC is a trademark of the International Business Machines Corporation. QuickTime is a trademark used under license. All other brand and product names are trademarks or registered trademarks of their respective owners.

FOR PROPER AND SAFE USE

NP-200 Lithium-ion batteries

The DiIMAGE Xg operates on a small, but powerful lithium-ion battery. Misuse or abuse of the lithium-ion battery can cause damage or injury through fire, electric shock, or chemical leakage. Read and understand all warnings before using the battery.

DANGER

- Do not short, disassemble, damage, or modify the battery.
- Do not expose the battery to fire or high temperatures over 60°C (140°F).
- Do not expose the battery to water, or moisture. Water can corrode or damage the internal battery safety devices and cause the battery to overheat, ignite, rupture, or leak.
- Do not drop or subject the battery to strong impacts. Impacts can damage the internal battery safety devices and cause the battery to overheat, ignite, rupture, or leak.
- Do not store the battery near or in metallic products.
- Do not use the battery with any other products.
- Only use the specified charger. An inappropriate charger may cause damage or injury through fire or electric shock.
- Do not use a leaking battery. If fluid from the battery enters your eye, immediately rinse the eye with plenty of fresh water and contact a doctor. If fluid from the battery makes contact with your skin or clothing, wash the area thoroughly with water.
- Only use or charge the battery in an environment with ambient temperatures between 0° and 40°C (32° and 104°F). Only store the battery in an environment with ambient temperatures between -20° and 30°C (-4° and 86°F) and a humidity of 45% to 85% RH.

WARNING

- Tape over the lithium-ion battery contacts to avoid short-circuiting during disposal; always follow local regulations for battery disposal.
- If charging is not completed after the specified period elapses, unplug the charger and discontinue charging immediately.

GENERAL WARNINGS AND CAUTIONS

Read and understand the following warnings and cautions for safe use of the digital camera and its accessories.

WARNING

- Only use the battery specified in this manual.
- Only use the specified charger or AC adapter within the voltage range indicated on the unit. An inappropriate adapter or current may cause damage or injury through fire or electric shock.
- Only use the charger power cord in the sales region for which it was designed. An inappropriate current may cause damage or injury through fire or electric shock.
- Do not disassemble the camera or charger. Electric shock may cause injury if a high voltage circuit inside the product is touched.
- Immediately remove the battery or unplug the AC adapter and discontinue use if the camera is dropped or subjected to an impact in which the interior, especially the flash unit, is exposed. The flash has a high voltage circuit which may cause an electric shock resulting in injury. The continued use of a damaged product or part may cause injuries or fire.
- Keep the battery, memory card, or small parts that could be swallowed away from infants. Contact a doctor immediately if an object is swallowed.
- Store this product out of reach of children. Be careful when around children not to harm them with the product or parts.
- Do not fire the flash directly into the eyes. It may damage eyesight.
- Do not fire the flash at vehicle operators. It may cause a distraction or temporary blindness which may lead to an accident.
- Do not use the monitor while operating a vehicle or walking. It may result in injury or an accident.
- Do not look directly at the sun or strong light sources through the viewfinder. It may damage your eyesight or cause blindness.

- Do not use these products in a humid environment, or operate them with wet hands. If liquid enters these products, immediately remove the battery or unplug the product, and discontinue use. The continued use of a product exposed to liquids may cause damage or injury through fire or electric shock.
- Do not use these products near inflammable gases or liquids such as gasoline, benzene, or paint thinner. Do not use inflammable products such as alcohol, benzene, or paint thinner to clean these products. The use of inflammable cleaners and solvents may cause an explosion or fire.
- When unplugging the AC adapter or charger, do not pull on the power cord. Hold the plug when removing it from an outlet.
- Do not damage, twist, modify, heat, or place heavy objects on the AC adapter or charger cord. A damaged cord may cause damage or injury through fire or electric shock.
- If these products emit a strange odor, heat, or smoke, discontinue use. Immediately remove the battery taking care not to burn yourself as the battery may become hot with use. The continued use of a damaged product or part may cause injuries or fire.
- Take the product to a Minolta Service Facility when repairs are required.
- Handling the cord on this product may expose you to lead, a chemical known to the State of California to cause cancer, and birth defects or other reproductive harm. Wash hands after handling.

CAUTION

- Do not use or store these products in a hot or humid environment such as the glove compartment or trunk of a car. It may damage the camera, charger, and battery which may result in burns or injuries caused by heat, fire, explosion, or leaking battery fluid.
- If the battery is leaking, discontinue use of the product.
- The camera, charger, and battery temperature rises with extended periods of use. Care should be taken to avoid burns.
- Burns may result if the memory card or battery is removed immediately after extended periods of use. Turn the camera off and wait for it to cool.
- Do not fire the flash while it is in contact with people or objects. The flash unit discharges a large amount of energy which may cause burns.
- Do not apply pressure to the LCD monitor. A damaged monitor may cause injury, and the liquid from the monitor may cause inflammation. If liquid from the monitor makes contact with skin, wash the area with fresh water. If liquid from the monitor comes in contact with the eyes, immediately rinse the eyes with plenty of water and contact a doctor.
- When using the AC adapter and charger, insert the plug securely into the electrical outlet.
- Do not use transformers or travel adapters with the charger. The use of these devices may cause a fire or damage the product.
- Do not use if the AC adapter, DC adapter, or charger cord is damaged.
- Do not cover the AC adapter or charger. A fire may result.
- Do not obstruct access to the AC adapter or charger; this can hinder the unplugging of the units in emergencies.
- Unplug the AC adapter or charger when cleaning or not in use.

The following marks may be found on the product:



This mark on your camera certifies that this camera meets the requirements of the EU (European Union) concerning interference causing equipment regulations. CE stands for Conformité Européenne (European Conformity).

This Class B digital apparatus complies with Canadian ICES-003.

Cet appareil numérique de la classe B est conforme à la norme NMB-003 du Canada.

FCC Compliance Statement Declaration on Conformity

Responsible Party: Konica Minolta Photo Imaging USA Inc.
Address: 725 Darlington Avenue, Mahwah, NJ 07430

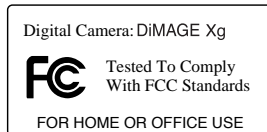

This device complies with Part 15 of the FCC Rules. Operation is subject to the following two conditions: (1) This device may not cause harmful interference, and (2) this device must accept any interference received, including interference that may cause undesired operation. Changes or modifications not approved by the party responsible for compliance could void the user's authority to operate the equipment.

This equipment has been tested and found to comply with the limits for a Class B digital device, pursuant to Part 15 of the FCC Rules. These limits are designed to provide reasonable protection against harmful interference in a residential installation. This equipment generates, uses and can radiate radio frequency energy and, if not installed and used in accordance with the instructions, may cause harmful interference to radio communications. However, there is no guarantee that interference will not occur in a particular installation. If this equipment does cause harmful interference to radio or television reception, which can be determined by turning the equipment off and on, the user is encouraged to try to correct the interference by one or more of the following measures:

- Reorient or relocate the receiving antenna.
- Increase the separation between the equipment and the receiver.
- Connect the equipment to an outlet on a circuit different from that to which the receiver is connected.
- Consult the dealer or an experienced radio/TV technician for help.

Do not remove the ferrite cores from the cables.

TABLE OF CONTENTS

The getting up and running section covers how to prepare the camera for use. It contains important information about power supplies and memory cards. The basic operation of this camera is covered in the recording - basic operation section between pages 24 and 35, and the playback - basic operation section between pages 36 and 39. Read the data-transfer mode section in its entirety before connecting the camera to a computer.

Many of the features of this camera are controlled with menus. The menu navigation sections concisely describe how to change menu settings. Descriptions of the settings immediately follow the navigation sections.

The appendix contains a troubleshooting section to help answer questions about the operation of the camera. Information covering camera care and storage is also provided. Please store this manual in a safe place.

Names of parts	12
Getting up and running.....	14
Inserting the lithium-ion battery	14
Charging the lithium-ion battery	15
Battery-condition indicator	16
Auto power off	16
AC adapter set (sold separately).....	17
Attaching the hand strap	19
Installing and removing a memory card	20
About memory cards	21
Setting the date and time	22
Recording - basic operation	24
Handling the camera	24
Setting the camera to record images	24
Using the zoom lens.....	25
LCD monitor display - basic	26
Camera-shake warning	26
Basic recording operation.....	27
Automatic digital subject program selection	28
Focus lock	30
Focus range.....	30

Focus signals.....	31
Special focusing situations.....	31
Flash modes.....	32
Flash range - Automatic operation.....	33
Flash signals.....	33
Display button - recording mode.....	34
Digital subject programs.....	35
Playback - basic operation.....	36
Single-frame playback display.....	36
Viewing images.....	37
Deleting single images.....	37
Display button - playback mode.....	38
Display button - Quick View.....	38
Enlarged playback.....	39
Recording - advanced operation.....	40
LCD monitor display - advanced.....	40
Exposure compensation.....	40
Navigating the recording-mode menu.....	42
Drive modes.....	44
Continuous advance.....	45
Self-timer.....	46
Multi frame.....	47
Image size and image quality.....	48
White balance.....	50
Customizing key functions.....	51
Camera sensitivity - ISO.....	52
Flash range and camera sensitivity.....	52
Metering modes.....	53
Compensating exposure with the menu.....	54
Noise reduction.....	54
Auto reset.....	55
Color mode.....	56
Voice memo.....	56
Date imprinting.....	58
Digital zoom.....	59
Instant playback.....	60
Spot AF.....	61
Recording without a memory card.....	62
Movie and audio recording.....	63
Movie recording.....	63

Audio recording	64
Navigating the movie/audio recording menu	65
Movie file sizes	67
Notes on movie recording	67
Playback - advanced operation	68
Playing back voice memos and audio captions	68
Playing back movies and audio recordings	69
Navigating the playback-mode menu	70
Frame-selection screen	72
Deleting image and audio files	73
Audio caption	74
Locking image and audio files	75
Image pasting	76
Cropping frames	78
Frame capture	80
Movie editor	82
About DPOF	84
Creating a DPOF print order	84
Date print / Index print	85
E-mail copy	86
Setup mode	88
Opening the setup menu	88
Navigating the setup menu	89
LCD monitor brightness	91
Formatting memory cards	91
File number (#) memory	92
Folder Name	92
Language	93
Audio signals	93
Shutter FX	93
Custom FX recording	94
Volume	95
Auto power off	95
Reset default	96
Date and time	97
Date format	97
Transfer mode	97
Data-transfer mode	99
System requirements	99
Connecting the camera to a computer	100

Connecting to Windows 98 and 98SE.....	102
Automatic installation.....	102
Manual installation.....	103
Auto power off - data-transfer mode.....	105
QuickTime 6 system requirements.....	105
Memory card folder organization.....	106
Disconnecting the camera from the computer.....	108
Windows XP, 2000 Professional, and Me.....	108
Windows 98 / 98 Second Edition.....	109
Macintosh.....	109
Changing the memory card - data-transfer mode.....	110
Using PictBridge compatible printer.....	110
Selecting print images.....	111
Navigating the PictBridge menu.....	113
Batch print.....	114
Index print.....	114
Paper size.....	114
Sizes.....	115
Layout.....	115
Print quality.....	115
Data print.....	115
DPOF print.....	116
Notes on printing errors.....	117
Remote camera system requirements.....	118
Installing the remote camera driver.....	118
Connecting the remote camera.....	120
Notes on remote camera operation.....	121
Appendix.....	122
Troubleshooting.....	122
About the lithium-ion battery charger cord.....	124
Viewfinder indicator lamps.....	125
Removing the driver software - Windows.....	126
Care and storage.....	127
Technical specifications.....	130

NAMES OF PARTS

* This camera is a sophisticated optical instrument. Care should be taken to keep these surfaces clean. Please read the care and storage instructions in the back of this manual (p. 107).

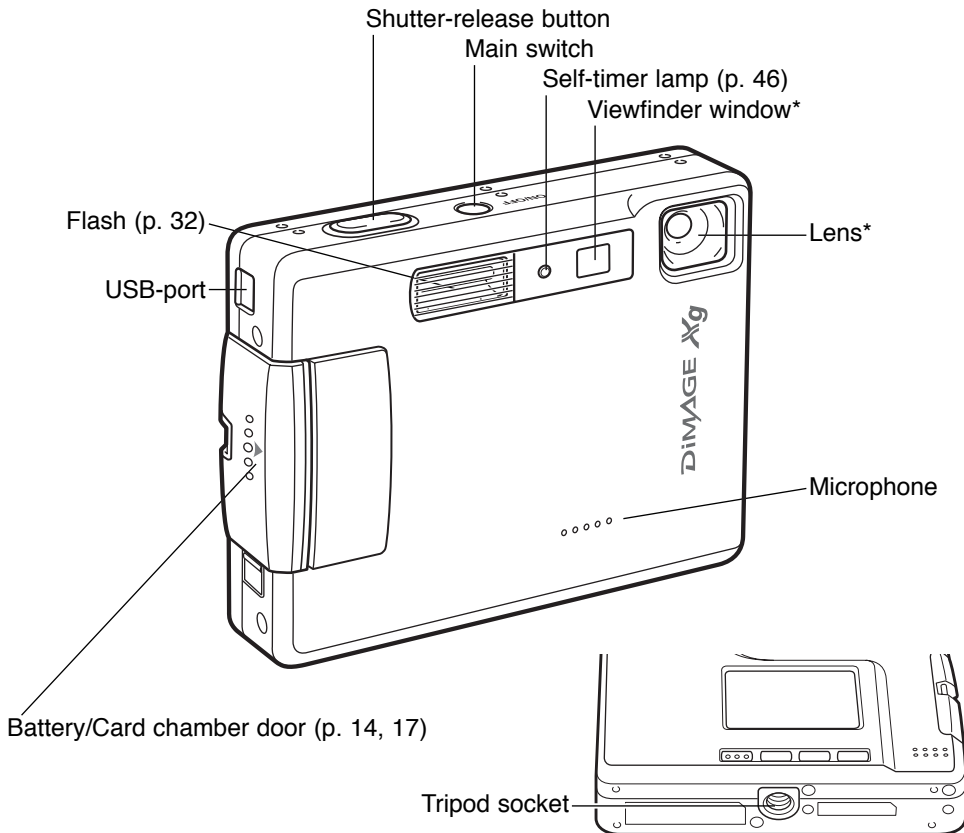

- Digital-subject-program mode (p. 28) —
 - Recording mode (p. 24) —
 - Playback mode (p. 36) —
 - Movie/Audio recording mode (p. 63) —
- Mode dial

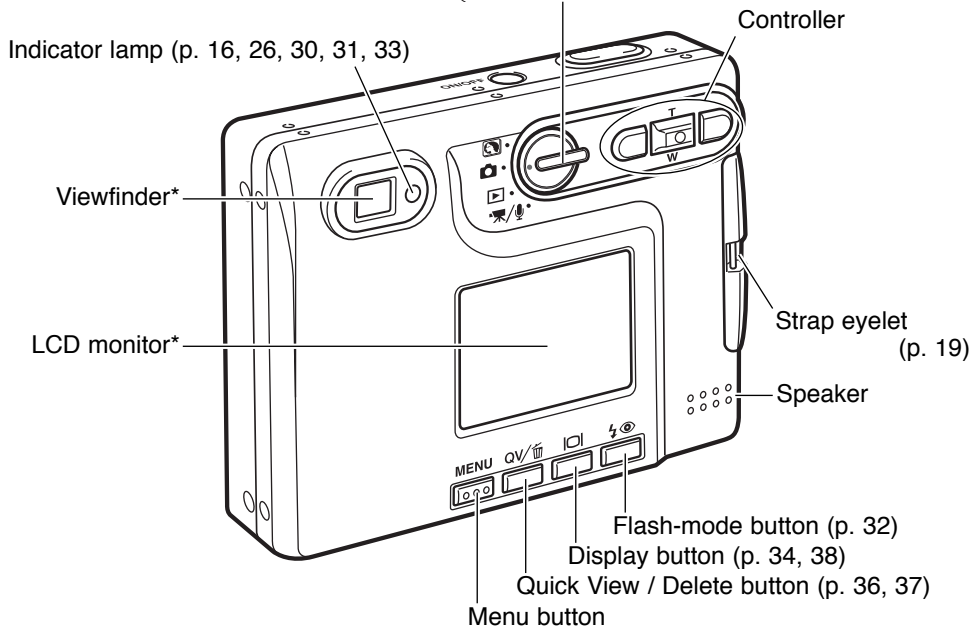

GETTING UP AND RUNNING

INSERTING THE LITHIUM-ION BATTERY

This digital camera uses one NP-200 lithium-ion battery. Before using the battery, read the safety warnings on pages 3 and 4 of this manual. When replacing the battery, the camera should be turned off.

Slide the battery-chamber door toward the front of the camera to release the safety catch (1). Open the door.

Move the battery latch towards the back of the camera to insert the battery (2). Slide the battery into the battery chamber with the battery terminals first until it is caught by the latch.

To remove the battery, move the latch towards the back of the camera until the battery is released (3). Pull the battery out of the chamber.

Close the battery-chamber door (4) and slide it toward the back of the camera to engage the safety catch.

After installing the battery, the set-time/date message may appear on the monitor. The clock and calendar is set in section 3 of the setup menu (p. 20). An internal battery protects the clock, calendar, and memory settings for more than 24 hours if the camera is used for at least 5 minutes before removing the battery.



CHARGING THE LITHIUM-ION BATTERY

Before the camera can be used, the lithium-ion battery must be charged. Before charging the battery, read the safety warnings on pages 3 and 4 of this manual. Only recharge the battery with the supplied battery charger. The battery should be recharged before each shooting session. See page 128 for battery care and storage.

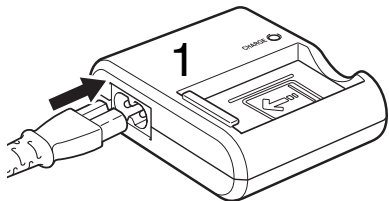

Plug the power cord into the back of the charger unit (1). Plug the other end of the cord into a live household outlet. The included AC cord is designed for the current of the sales region. Only use the cord in the region it was purchased. For more on the AC cable, see page 124.

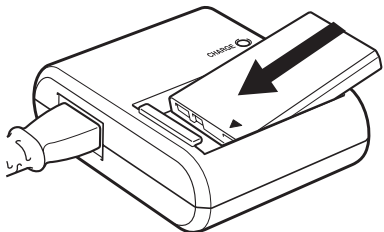

With the battery terminals forward and the label face up, slide the battery into the charger. The indicator lamp (2) will glow to show the battery is charging. The lamp will go out when the battery has been charged. Charging time is approximately 90 minutes.

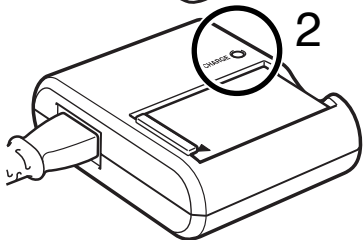

Remove the battery from the charger. Unplug the power cord from the outlet.

BATTERY-CONDITION INDICATOR

This camera is equipped with an automatic battery-condition indicator displayed on the LCD monitor. The icon will change from white to red when battery power is low.



Full-battery icon - the battery is fully charged. This icon is displayed when the camera is on.



Half-full-battery icon - the battery is partially charged. This icon is displayed when the camera is turned on. The LCD monitor will turn off when the flash is charging.



Low-battery warning - battery power is very low. The battery should be replaced as soon as possible. This warning automatically appears and remains on the monitor until the battery is recharged. If the power level falls below this level when the camera is on, the battery-exhausted message will appear just before the camera shuts down.

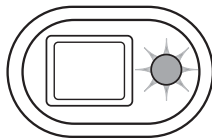

If power is insufficient for camera operation, the indicator lamp next to the viewfinder will turn red and blink for three seconds. The shutter will not release. The battery must be recharged.

AUTO POWER OFF

To conserve battery power, the camera will shut down if an operation is not made within three minutes. To restore power, press the main switch. The length of the auto-power-off period can be changed in section 2 of the setup menu (p. 95). When the camera is connected to a computer, the auto-power-off period is set to ten minutes and cannot be changed.

AC ADAPTER SET (SOLD SEPARATELY)



Always turn off the camera before changing between power supplies.

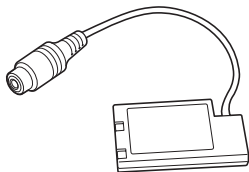

DC adapter DA-100

The AC adapter AC-4 or AC-5 allows the camera to be powered from a household outlet. The AC adapter is recommended when the camera is interfaced with a computer or during periods of heavy use. AC adapter model AC-4 is for use in North America, Japan, and Taiwan, and AC-5 is for use in all other areas. The battery cannot be charged using the AC adapter.

To use the AC Adapter AC-4 or AC-5 with this camera, DC Adapter DA-100 is required. DC Adapter DA-100 is included in the AC Adapter Set AC-401/501.

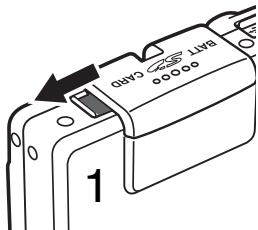

1. Open the cover on the side of the battery chamber and place the DC adapter cable in the notch (1).
2. Slide the battery-chamber door toward the front of the camera to release the safety catch (2). Open the door.

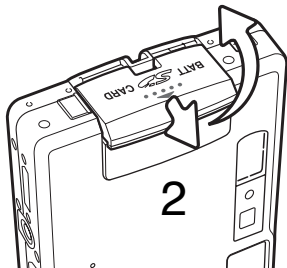

3. Move the battery latch towards the back of the camera to insert the DC plug. Slide the DC plug into the battery chamber with its terminals first until it is caught by the latch (3).

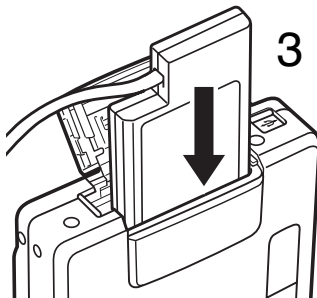

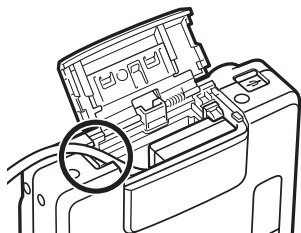

4. Placing the DC adapter cable in the notch, close the battery-chamber door and slide it toward the back of the camera to engage the safety catch (4).
5. Insert the mini plug of the AC adapter into the AC socket of the DC adapter (5).
6. Insert the AC adapter plug into an electrical outlet.

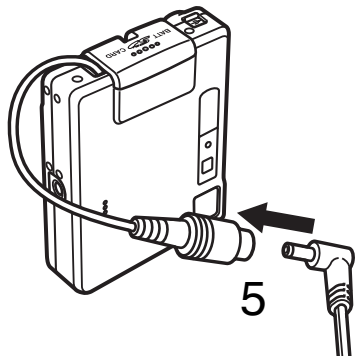
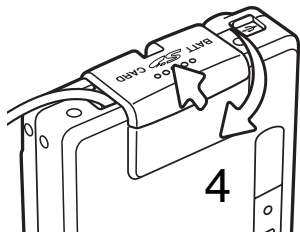

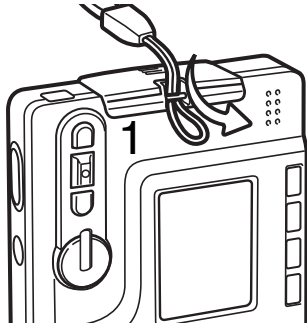

ATTACHING THE HAND STRAP

Always keep the strap around your wrist in the event that the camera is accidentally dropped.

Pass the small loop of the hand strap through the strap eyelet on the camera body (1).

Pass the other end of the strap through the small loop and tighten (2).

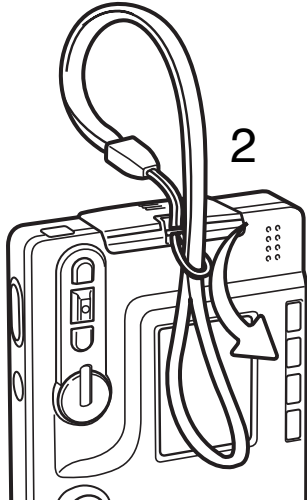

INSTALLING AND REMOVING A MEMORY CARD



Always turn off the camera and confirm the indicator lamp is not orange and blinking before changing the memory card, otherwise the card may be damaged, and data lost.

An SD (Secure Digital) Memory card or MultiMediaCard must be inserted for the camera to operate. If a card has not been inserted, a no-card warning will appear on the LCD monitor; the shutter can still be released and a single image can be captured (p. 62).

Slide the battery-chamber door toward the bottom of the camera to release the safety catch (1). Open the door.

Insert the memory card all the way into the card slot and then release (2). The card should catch in the slot.

Insert the card so the face is toward the front of the camera. Always push the card in straight, never at an angle. Never force the card. If the card does not fit, check that it is orientated correctly. If a MultiMediaCard is inserted incorrectly, it will lock, but the card chamber door will not close.

To eject a memory card, press the card into the slot and release (3). The card can now be pulled out.

Close the battery-chamber door and slide it toward the top of the camera to engage the safety catch (4).

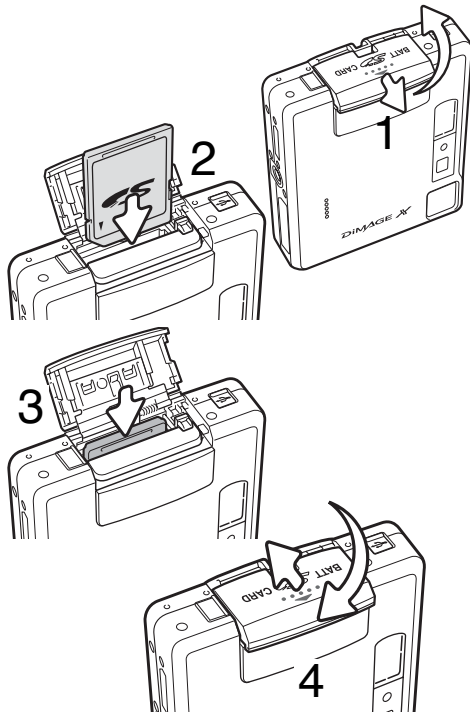

ABOUT MEMORY CARDS

The response time during recording and playback is longer with MultiMediaCards compared with SD Memory Cards. This is not a defect, but rather due to the specifications of the cards. When using large capacity cards, some operations like deletion may take longer.

The SD Memory Card has a write-protect switch to prevent image data from being deleted. By sliding the switch to the bottom of the card, the data will be protected. However, when the card is protected, images cannot be recorded. If an attempt is made to record or delete an image with the camera, the card-locked message will appear and the LED lamps near the viewfinder will turn red and blink quickly. For memory card care and store see page 128.

If the unable-to-use-card message appears, the inserted card in the camera may need to be formatted. A card used in another camera may also have to be formatted before being used. A card can be formatted in section 1 of the setup menu (p. 91). When a card is formatted, all the data on the card is permanently erased.

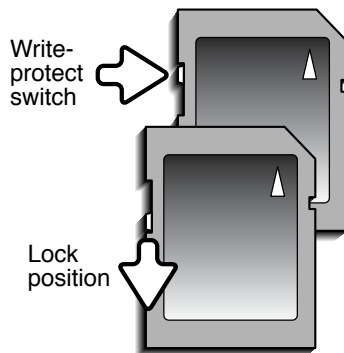

SETTING THE DATE AND TIME

When images are recorded, the image data is saved with the date and time of recording. After initially inserting a memory card and charging the battery, the following message will be displayed in the LCD monitor to prompt the date and time setup.

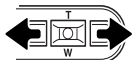

Use the left and right keys to select “Yes,” “No” cancels the message.

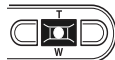

Press the central button to display the date/time setting screen.

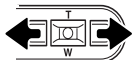

Use the left and right keys to select the item to be changed.



Use the up and down keys to adjust the item.

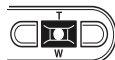

Press the central button to set the clock and calendar.

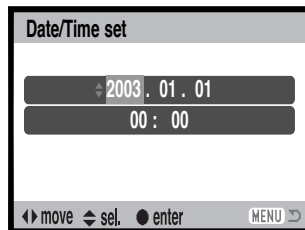

Date/Time setting screen

To set the camera's clock and calendar at another time, use the following procedure.

Turn the camera on by pressing the main switch near the shutter-release button.

Press the menu button to open the menu; the appearance of the menu depends on the position of the mode dial.

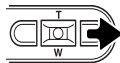
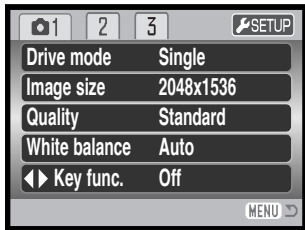

Use the right key to highlight “setup” at the top of the menu.

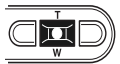

Press the central button to open the setup menu.



Setup menu

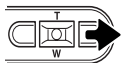
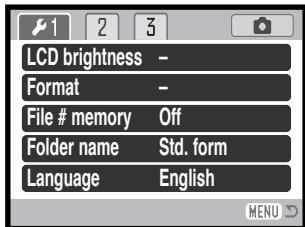

Use the right key to highlight the third tab at the top of the menu.



Use the down key to highlight the **Date/Time set** menu option.

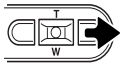

Press the right key. “**Enter**” will appear on the right side of the menu.



Press the central button to display the date/time setting screen.

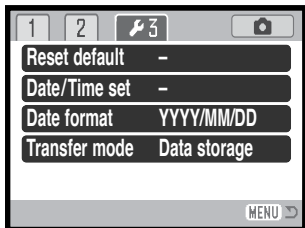

Setup menu: section 3

Camera notes

For customers in certain areas, the menu language must also be set. Highlight the language option in section 1 of the setup menu. Press the right key to display the language settings. Using the up/down keys, highlight the desired language. Press the central button to set the highlighted language; the setup menu will be displayed in the selected language.

RECORDING MODE - BASIC OPERATION

This section covers basic recording operation. To prepare the camera for use, read pages 14 through 23.

HANDLING THE CAMERA

While using the viewfinder or LCD monitor, grip the camera firmly with your right hand while supporting the camera body with your left. Keep your elbows at your side and your feet shoulder-width apart to hold the camera steadily.

When taking vertical pictures, hold the camera so that the flash is above the lens with the shutter-release button to the top. Take care not to cover the lens with your fingers or the strap.



SETTING THE CAMERA TO RECORD IMAGES

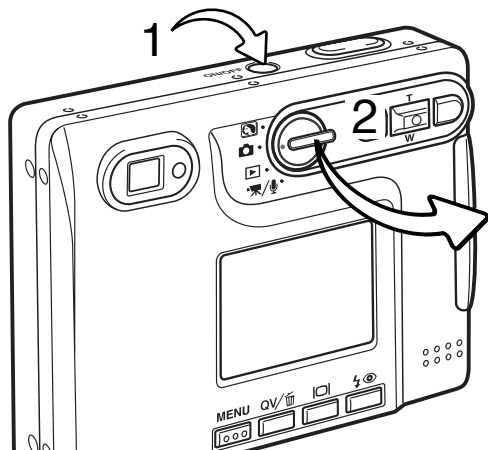

Turn the camera on by pressing the main switch near the shutter-release button (1).

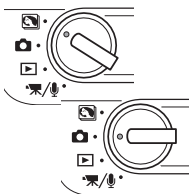

Turn the mode dial to the digital subject program mode or recording mode position (2).

When the camera is turned on, the monitor may turn off for a few seconds while the flash charges.

USING THE ZOOM LENS

This camera is equipped with a unique 5.7 - 17.1mm zoom lens. This is equivalent to a 37 to 111mm lens on a 35mm camera. The lens is operated by the controller at the back of the camera. The effect of the optical zoom is visible in both the viewfinder and LCD monitor.

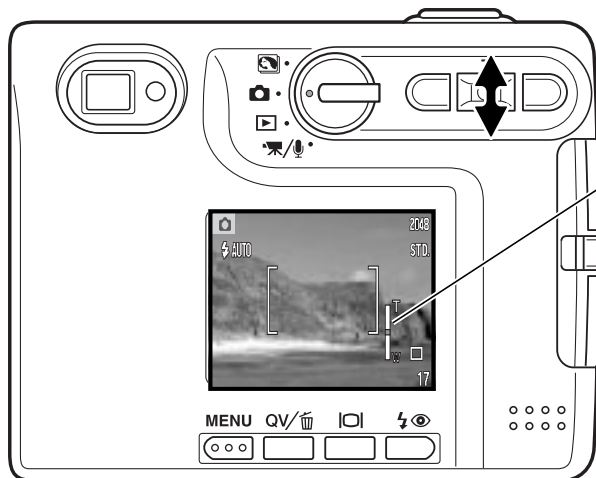

To zoom in on the subject, push the up key (T) of the controller.

To zoom out, push the down key (W) of the controller.

While zooming, the zoom indicator is displayed on the LCD monitor to show the approximate zoom position.

The digital-zoom function can increase the power of the lens. The digital zoom is activated in section 3 of the recording-mode menu (p. 59).

Shooting tips

The zoom lens not only affects how large the subject is in the picture, but it also influences the depth of field and perspective. Depth of field is the area between the closest object in focus and the furthest object in focus. As the lens zooms in to the telephoto position, the depth of field becomes shallower, separating the subject from the background. Many portraits are taken with telephoto lenses. Zooming the lens out to the wide-angle position makes both the foreground and background appear sharper. Usually landscape photographs take advantage of the large depth of field of wide-angle lenses. Wide-angle lenses also create a strong perspective which gives a sense of depth in the image. Telephoto lenses compress the space between the subject and background and create a weak perspective.

LCD MONITOR DISPLAY - BASIC

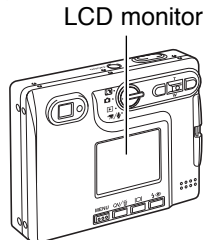
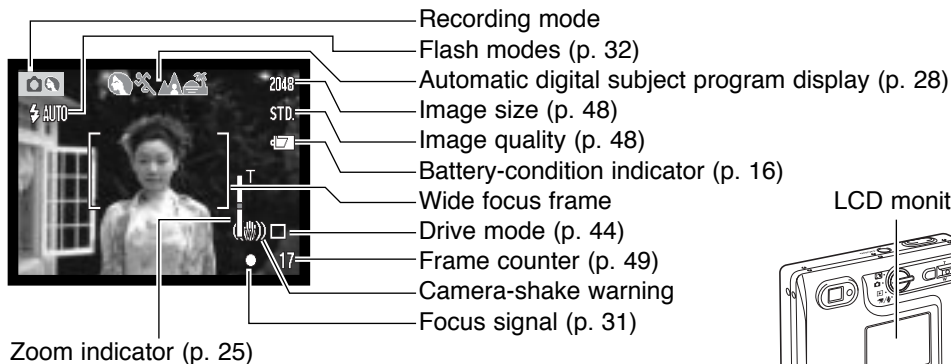

CAMERA-SHAKE WARNING



If the shutter speed falls below the point where the camera can be hand held safely, the camera-shake warning indicator will appear on the monitor and the viewfinder indicator lamp will turn green and blink slowly. Camera shake is slight blurring caused by subtle

hand motion and is more pronounced at the telephoto position of the lens than at the wide-angle position. Although the warning appears, the shutter can still be released. If the warning appears, place the camera on a tripod or use the built-in flash.

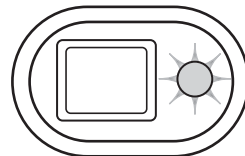

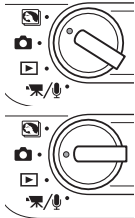

BASIC RECORDING OPERATION

Turn the camera on and turn the mode dial to the digital-subject-program mode or recording-mode position. The operation for both modes is the same. Automatic Digital Subject Program Selection is only active in the digital-subject-program mode.

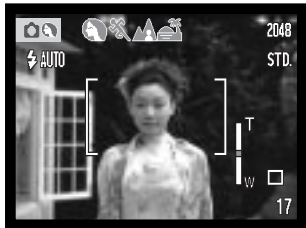

Place the subject within the focus frame on the LCD monitor or center the subject in the viewfinder.

- The focus-lock function (p. 30) can be used with off-center subjects.
- If the subject is closer than 1m (3ft.) at the zoom lens' wide-angle position or 3m (10ft) at the telephoto position, only use the LCD monitor to frame the subject.
- The spot focus area can be used for focusing; press the center controller button for about 1 second to activate the area (p. 61).

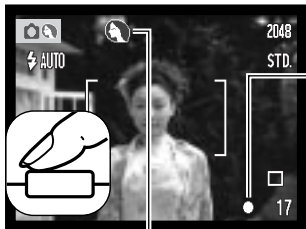

Press the shutter-release button partway down to lock the focus and exposure.

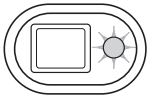
- The focus signals (p. 31) on the monitor and the indicator lamp next to the viewfinder will confirm that the image is in focus. If the monitor focus signal is red or the indicator lamp is green and blinks quickly, the camera was unable to focus on the subject. Repeat the previous steps until the focus signal is white and the lamp glows steadily. 
- In the digital-subject-program mode, Automatic Digital Subject Program Selection chooses the appropriate exposure program, see the next page.

(Continued on next page)

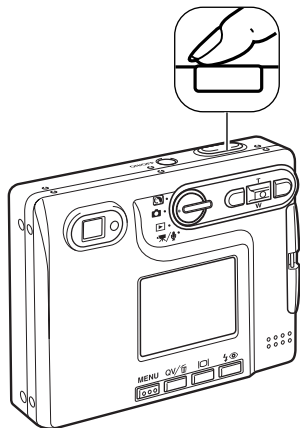

Press the shutter-release button all the way down to take the picture.

- After the shutter releases, the indicator lamp next to the viewfinder will turn orange and blink indicating image data is being written to the memory card. **Never remove a memory card while data is being transferred.**
- The image can be previewed after it is captured by continuing to hold down the shutter-release button. This function is disabled if the monitor is off. Instant playback also can be used (p. 60).



Automatic Digital Subject Program Selection

Automatic Digital Subject Program Selection chooses between program AE and one of four digital subject programs. The digital subject programs optimize camera setting for various conditions and subjects. Automatic Digital Subject Program Selection is only available in the digital-subject-program mode. For information on individual subject programs, see page 35.

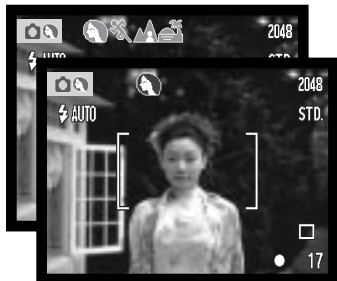

A row of gray indicators at the top on the monitor display indicate Automatic Digital Subject Program Selection is active.

Press the shutter-release button partway down; the AF system locates the subject and the Automatic Digital Subject Program Selection chooses a subject program. If no indicators are displayed, programmed AE is active. Press the shutter-release button all the way down to take the picture.



Program autoexposure (the Digital Subject Program indicators disappear)



Portrait



Sports action



Landscape



Sunset

Hold the camera steadily when the sunset subject program is selected as exposures can be long.



In the digital-subject-program mode, one of five digital subject programs can be selected manually by using the left and right keys of the controller before taking a picture. See page 35.

FOCUS LOCK

The focus-lock function is used when you want to compose the image with the subject off-center and outside the focus frame. Focus lock may also be used when a special focusing situation prevents the camera from focusing on the subject. This function is controlled with the shutter-release button.

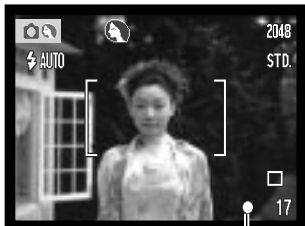

Place the subject within the monitor focus frame or center the subject in the viewfinder. Press and hold the shutter-release button partway down to lock the focus.

- The focus signal on the monitor and the viewfinder indicator lamp will indicate if the focus is locked.

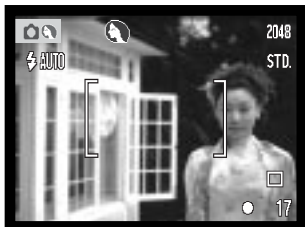
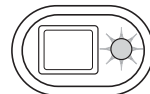

Without lifting your finger from the shutter-release button, recompose the subject within the image area. Press the shutter-release button all the way down to take the picture.

FOCUS RANGE

The focus range is 15cm (0.5ft.) to infinity. Both the LCD monitor and viewfinder can be used to frame the subject. However, because of parallax, only the monitor's live image will be accurate with subjects closer than 1m (3ft.) at the zoom lens' wide-angle position or 3m (10ft) at the telephoto position.

FOCUS SIGNALS

This digital camera has a quick, accurate autofocus system. The focus signal in the lower right corner of the LCD monitor and the indicator lamp next to the viewfinder indicate the focus status. The shutter can be released regardless if the camera can focus on the subject or not.

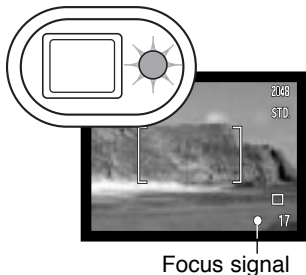

Focus confirmed - the LCD monitor focus signal is white, the viewfinder indicator lamp is green and steady. Focus is locked.

Cannot focus - the LCD monitor focus signal is red and the viewfinder indicator lamp is green and blinks rapidly.

SPECIAL FOCUSING SITUATIONS

The camera may not be able to focus in certain situations. In these situations the focus-lock function (p. 30) can be used to focus on another object at the same distance as your main subject, and then the image can be recomposed to take the picture.

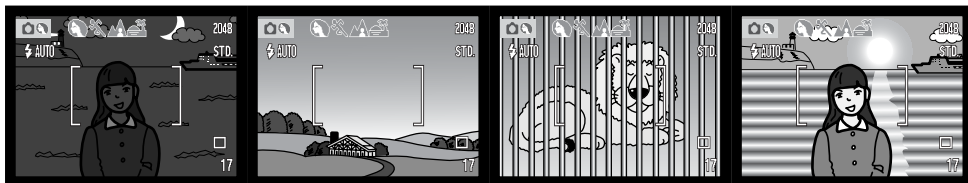

The subject is too dark.

The subject in the focus frame is low in contrast.

Two subjects at different distances overlap in the focus frame.

The subject is near a very bright object or area.

FLASH MODES

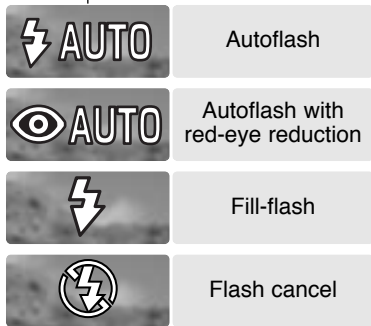
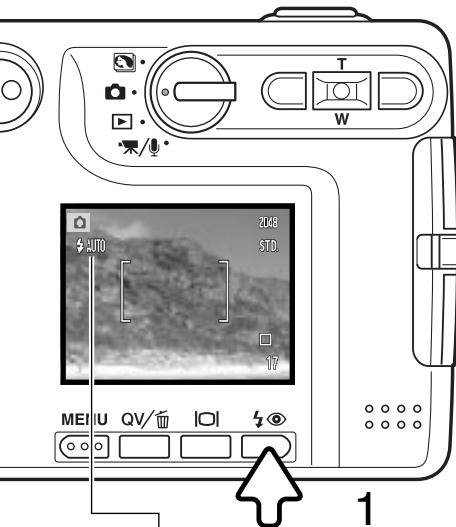

The flash can be used when taking still images. To select the flash mode, press the flash mode button (1) on the back of the camera until the desired mode is displayed. Press the shutter-release button to set the mode. The active flash mode is displayed in the top left corner of the LCD monitor. When the camera is turned off and auto reset (p. 55) is active, the flash mode is reset to autoflash with red-eye reduction if this mode was last set, if not the mode will be reset to autoflash. While the flash is charging, the shutter cannot be released.

Autoflash - the flash fires automatically in low-light and backlit conditions.

Red-eye reduction - the flash fires multiple bursts before the main flash burst to reduce red-eye; an effect caused by light reflected from the retina. Use in low-light conditions when taking photographs of people or animals, the pre-flashes contract the pupils of the subject's eyes.



Fill-flash - the flash fires with each exposure regardless of the amount of ambient light. Fill-flash can be used to reduce harsh shadows caused by strong direct light or sunshine.

Flash cancel - the flash will not fire. Use flash cancel when flash photography is prohibited, natural light is desired to illuminate the subject, or the subject is beyond the flash range. The camera-shake warning may appear when flash cancel is selected (p. 26).

FLASH RANGE - AUTOMATIC OPERATION

The camera automatically controls the flash output. For well-exposed images, the subject must be within the flash range. Because of the optical system, the flash range is not the same at the lens' wide-angle position as it is at the telephoto position. The flash ranged can be changed with camera sensitivity (ISO), see page 52.

Wide-angle position

0.15m ~ 3.2m (0.5 ft. ~ 10.5 ft.)

Telephoto position

0.15m ~ 2.5m (0.5 ft. ~ 8.2 ft.)

FLASH SIGNALS

The indicator lamp next to the viewfinder indicates the status of the flash. When the lamp is red and blinks quickly, the flash is charging and the shutter will not release. When the lamp turns green, the flash is charged and ready to fire.

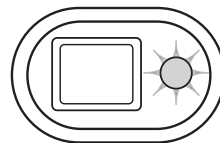

DISPLAY BUTTON - RECORDING MODE

The display button controls the LCD monitor display. The display cycles to the next position each time the button is pressed: full display, live image only, and monitor off. If the display button is pressed and held, the LCD-brightness adjustment screen will be displayed, see page 91.

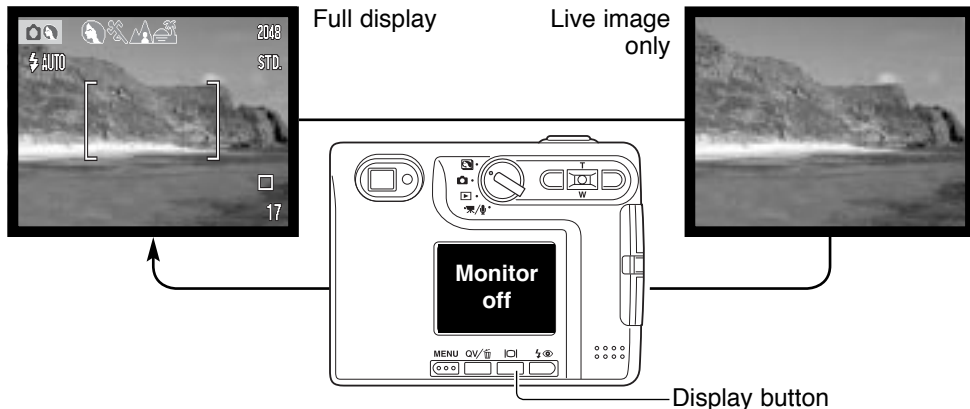

Battery power can be conserved by turning the monitor off and using the viewfinder to take pictures. However, because of parallax, the monitor should be used for subjects closer than 1m (3ft.) at the zoom lens' wide-angle position or 3m (10ft) at the telephoto position.

When the flash-mode or menu button is pressed, the monitor will automatically turn on. The battery-condition and date-imprinting indicators can appear on the live image only display. The digital zoom is canceled and the AF area and exposure-compensation setting is fixed when the monitor is off. The monitor cannot be turned off in audio or movie recording. When the LCD monitor is off, it will automatically activate for the instant playback period. When auto reset is active, the LCD monitor will be reset to the full display when the camera is turned off.

DIGITAL SUBJECT PROGRAMS

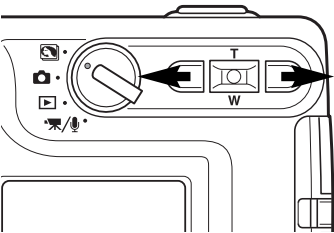

Digital subject programs optimize the camera's exposure, white-balance, and image-processing systems for specific conditions and subjects. Simply press the left and right keys of the controller to select the appropriate subject program; the active subject program is displayed at the top of the monitor.



Portrait - optimized to reproduce warm, soft skin tones and a slight defocusing of the background. Most portraits look best at a telephoto setting; the longer focal length does not exaggerate facial features and the shallower depth of field softens the background. Use the built-in flash with strong direct sunlight or backlight to reduce harsh shadows.



Sports action - used to capture action by maximizing shutter speeds. When using flash, the subject must be within the flash range (p. 33). A monopod is more flexible and compact than a tripod when shooting events.



Landscape - optimized to produce sharp, colorful landscapes. Used with bright outdoor scenery.



Sunset - optimized to reproduce rich, warm sunsets. When the sun is above the horizon, do not point the camera toward the sun for prolonged periods of time. The intensity of the sun could damage the CCD. Between exposures, turn off the camera or cover the lens.



Night portrait - for deep, subtle night scenes. The use of a tripod is recommended. When used with flash, the subject and background exposures are balanced. The flash can only be used with close subjects such as with a portrait of a person. When using the flash, ask your subjects not to move after the burst; the shutter will still be open for the background exposure.

PLAYBACK - BASIC OPERATION

Images can be viewed in the Quick View or playback modes. This section covers the basic operation in both modes. The playback mode has additional functions, see page 68.

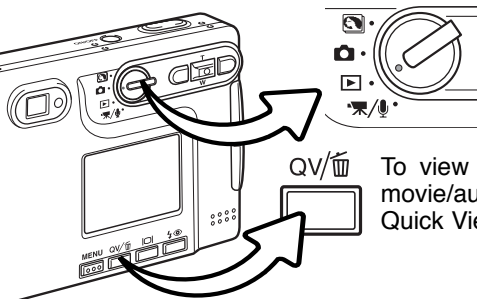

To view images from the playback mode, turn the mode dial to the playback position.

To view images from the recording or movie/audio recording mode, press the Quick View / Delete button.



SINGLE-FRAME PLAYBACK DISPLAY

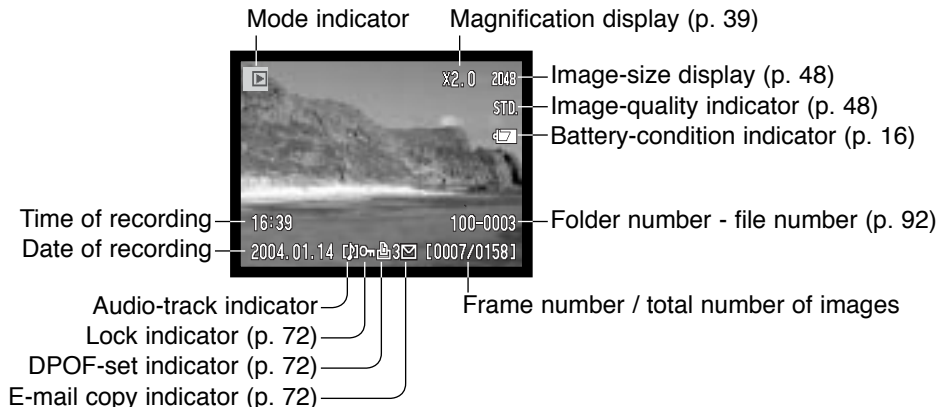

VIEWING IMAGES

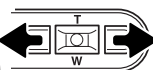
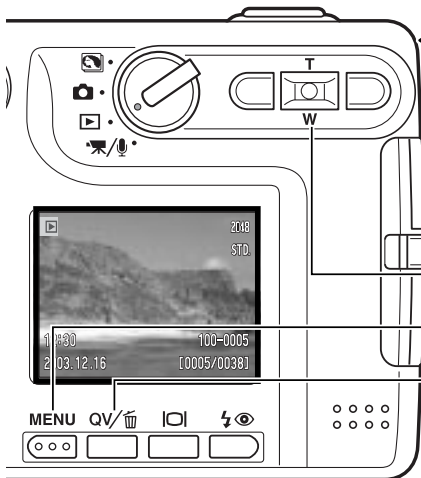

In Quick View or the playback mode, use the left/right keys of the controller to scroll through the images on the memory card.

To return to the recording mode from Quick View, press the menu button or press the shutter-release button partway down.

Controller

Menu button

Quick View / Delete button

DELETING SINGLE IMAGES

To delete a displayed file, press the flash-mode/delete button. A confirmation screen will appear.

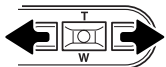

Use the left/right keys to select "Yes." "No" will cancel the operation.



Press the center button of the controller to delete the file.

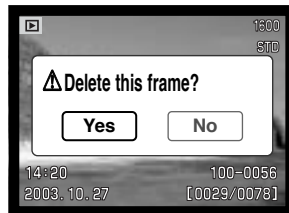

DISPLAY BUTTON - PLAYBACK MODE

The display button controls the display format. Each time the button is pressed, the display cycles through to the next format: full display, image only, index playback.

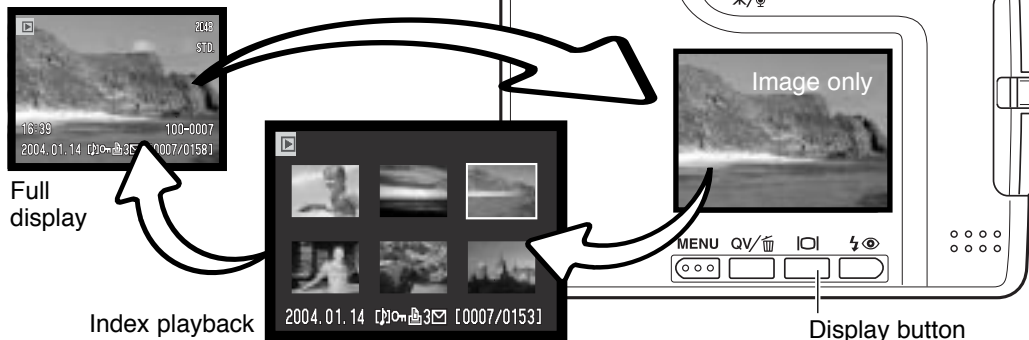

In index playback, the left/right and up/down keys of the controller move the yellow border around the index thumbnails. When the image is highlighted with the border, the date of recording, audio-track indicator, the lock and printing status, e-mail copy indicator and the frame number of the image are displayed at the bottom of the screen. The accompanying audio track of the highlighted image can be played by pressing the center button of the controller. When the display button is pressed again, the highlighted image will be displayed in the single-frame playback mode.

DISPLAY BUTTON - QUICK VIEW

Pressing the display button in Quick View switches between the full display and the image-only display.

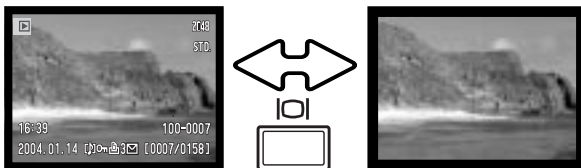

ENLARGED PLAYBACK

In single-frame playback in both the Quick View and playback modes, a still image can be enlarged by up to 6X in 0.2X increments.



With the image to be magnified displayed, press the up key of the controller to activate the enlarged playback mode. The degree of magnification is displayed on the LCD monitor.

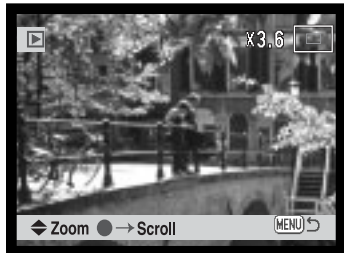

Pressing the up key increases the image magnification. Pressing the down key decreases the image magnification.



The display button switches between showing the full display and image only.

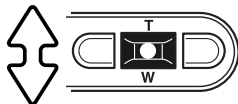

To scroll the image, press the center button of the controller. The center button switches between the enlarged-playback and scroll screens.



Use the left/right and up/down keys of the controller to scroll the image.



To exit the enlarged playback mode, press the menu button.



The locator indicator in the top right corner of the monitor shows the area of the image being displayed.

RECORDING - ADVANCED OPERATION

LCD MONITOR DISPLAY - ADVANCED

Microphone indicator

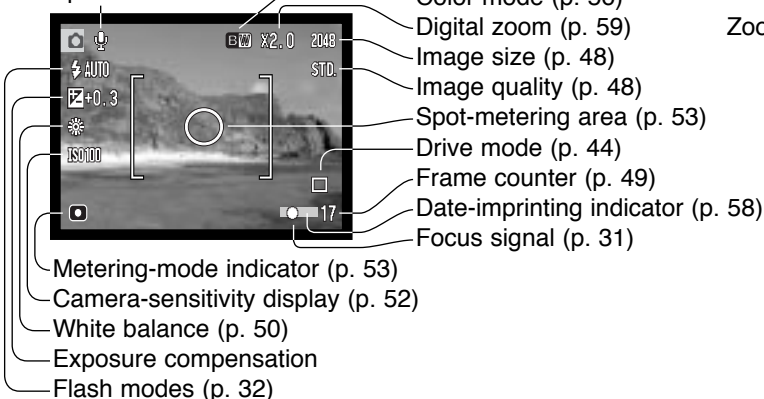

Zoom indicator (p. 59)

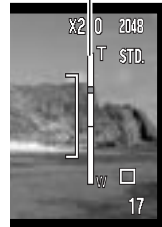

EXPOSURE COMPENSATION



The camera exposure can be adjusted to make the final picture lighter or darker by as much as $\pm 2\text{Ev}$ in $1/3$ increments with still image and movie recording. The exposure-compensation value will remain in effect until it has been reset. Exposure compensation can also be set in section 2 of the recording-mode menu (p. 54). The function controlled with the left/right keys of the controller can be changed with the menu, see page 51.

The exposure compensation must be set before the image is captured. When setting the exposure compensation, the amount of compensation is shown next to the exposure-compensation icon on the monitor. When set to any value other than 0.0, the icon will remain on the LCD monitor as a warning. To set the exposure compensation, the monitor must be on.

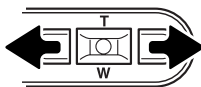
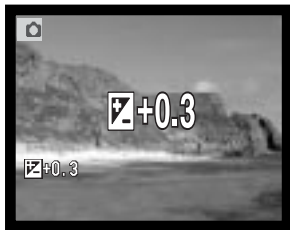

Use the left/right controller keys to adjust the exposure-compensation value.

The LCD monitor will display the exposure-compensation icon and value. The change in exposure is visible in the monitor image. Exposure compensation is set automatically after five seconds or when another camera button is pressed.

Shooting tips

Sometimes the camera's exposure meter is deceived by certain conditions. Exposure compensation can be used in these situations. For example, a very bright scene, such as a snowy landscape or a white sandy beach, can appear too dark in the captured image. Before taking the picture, adjusting the exposure by +1 or +2 EV will result in an image with normal tonal values.



Calculated camera exposure



-1.0Ev



-2.0Ev

In the example above, the dark water caused the camera to overexpose the image making it bright and washed-out. By compensating the exposure, detail is brought out in the leaves, and the stones and water appear richer.

Ev stands for exposure value. A change of one Ev will adjust the exposure calculated by the camera by a factor of two.

+2.0 Ev	4X as much light
+1.0 Ev	2X as much light
0.0 Ev	Calculated exposure
-1.0 Ev	1/2 as much light
-2.0 Ev	1/4 as much light

NAVIGATING THE RECORDING-MODE MENU

Navigating the menu is simple. The menu button turns the menu on and off. The left/right and up/down keys of the controller control the cursor and change settings on the menu. Pressing the center button of the controller selects menu options and sets adjustments.

MENU



To activate the recording-mode menu, press the menu button.

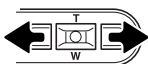

The section 1 tab at the top of the menu will be highlighted. Use the left/right keys to highlight the appropriate menu tab; the menus will change as the tabs are highlighted.



When the desired menu section is displayed, use the up/down key to scroll through the menu options. Highlight the option whose setting needs to be changed.

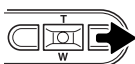

With the menu option highlighted, press the right key; the settings will be displayed with the current setting highlighted. To return to the menu options, press the left key.





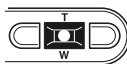
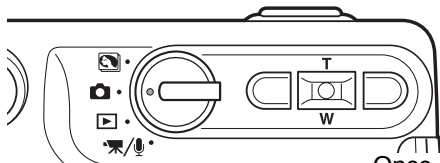

Use the zoom lever to highlight the new setting.

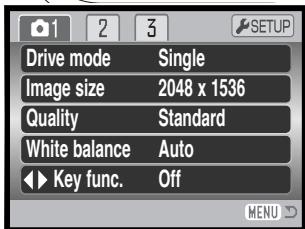

Press the center button of the controller to select the highlighted setting.



Once a setting has been selected, the cursor will return to the menu options and the new setting will be displayed. Changes can continue to be made. To return to the recording mode, press the menu button.

Section 1	
Drive mode	Single
	Continuous
	Self-timer
	Multi frame
	2048 X 1536
Image size	1600 X 1200
	1280 X 960
	640 X 480
Quality	Fine
	Standard
	Economy
White balance*	Auto
	 Daylight
	 Cloudy
	 Tungsten
	 Fluorescent
	Exp. comp.
◀▶ Key func.*	White balance
	Drive mode
	Sensitivity
	Off
	Off

Section 2	
Sensitivity*	ISO 400
	ISO 200
	ISO 100
	ISO 50
	Auto
Metering mode*	Multi-segment
	Spot
Exp. comp.	-2.0 ~ +2.0 Ev
Noise reduction	On
	Off
Auto reset	On
	Off

Section 3	
Color mode*	Color
	B&W
	Sepia
Voice memo	On
	Off
Date imprinting	YYYY/MM/DD
	MM/DD/hr:min
	Off
Digital zoom	On
	Off
Instant playback	On
	Off

* White balance, ▶▶ key func., sensitivity, metering mode, and color mode options are not in active in the digital-subject-program mode.

Refer to the following sections for details on the menu options and their settings.

DRIVE MODES

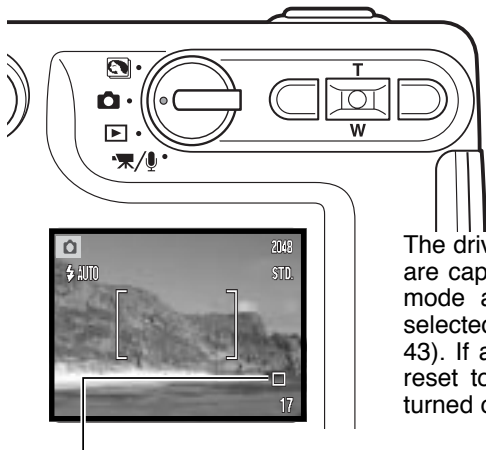

The drive modes control the rate and method images are captured. Indicators indicating the selected drive mode appear on the monitor. The drive mode is selected in section 1 of the recording-mode menu (p. 43). If auto reset (p. 55) is active, the drive mode is reset to single-frame advance when the camera is turned off.



Single-frame advance - to take a single image each time the shutter-release button is pressed. This is the camera's default setting.



Continuous advance - to take multiple images when the shutter-release button is pressed and held (p. 45).



Self-timer - to delay the release of the shutter (p. 46). Used for self-portraits.



Multi frame - to create a composite image of a nine-frame series when the shutter-release button is pressed once (p. 47).

Continuous advance



The continuous-advance drive mode allows a series of images to be captured while holding down the shutter-release button. The number of images that can be captured at one time and the rate of capture depend on the image-quality and image-size setting. With the image-size setting of 2048 X 1536, the maximum rate of capture is 1.5 fps. Continuous advance is selected in the section 1 of the recording-mode menu (p. 43).

Compose the picture as described in the basic recording operation section (p. 27). Press the shutter-release button partway down to lock the exposure and focus for the series (1). Press and hold the shutter-release button all the way down (2) to begin taking pictures. When the shutter-release button is pressed and held, the camera will begin recording images until the maximum number has been taken or the shutter button is released. The built-in flash can be used, but the rate of capture is reduced because the flash must recharge between frames. Date imprinting (p. 58) also reduces the rate of capture. The frame counter is adjusted after the series has been taken while the images are being saved.

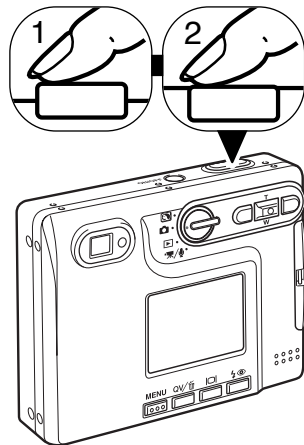

The chart lists the maximum number of images that can be captured with different image-quality and image-size combinations.

Image Quality \ Image Size	2048 X 1536	1600 X 1200	1280 X 960	640 X 480
Fine	5	8	13	42
Standard	10	16	24	67
Economy	19	30	42	94

Self-timer



Used for self-portraits, the self-timer will delay the release of the shutter for approximately ten seconds after the shutter-release button is pressed. The self-timer drive mode is selected in section 1 of the recording-mode menu (p. 43).

With the camera on a tripod, compose the picture as described in the basic recording operation section (p. 27). Focus lock (p. 30) can be used with off-center subjects. Press the shutter-release button partway down to lock the exposure and focus (1). Press the shutter-release button all the way down to begin the countdown (2). Because focus and exposure are determined when the shutter-release button is pressed, do not stand in front of the camera when taking a self-timer image. Always confirm the focus with the focus signals before beginning the countdown (p. 31).

A countdown timer is displayed on the monitor. During the countdown, the self-timer lamp on the front of the camera (3) will start to blink and is accompanied by an audio signal. A few seconds before the exposure, the self-timer lamp will blink rapidly. The lamp will glow steadily just before the shutter fires.

To stop the countdown, press the up/down keys of the controller or the menu button. The drive mode will be reset to single-frame advance after the exposure. The audio signal can be turned off in section 2 of the setup menu (p. 93).

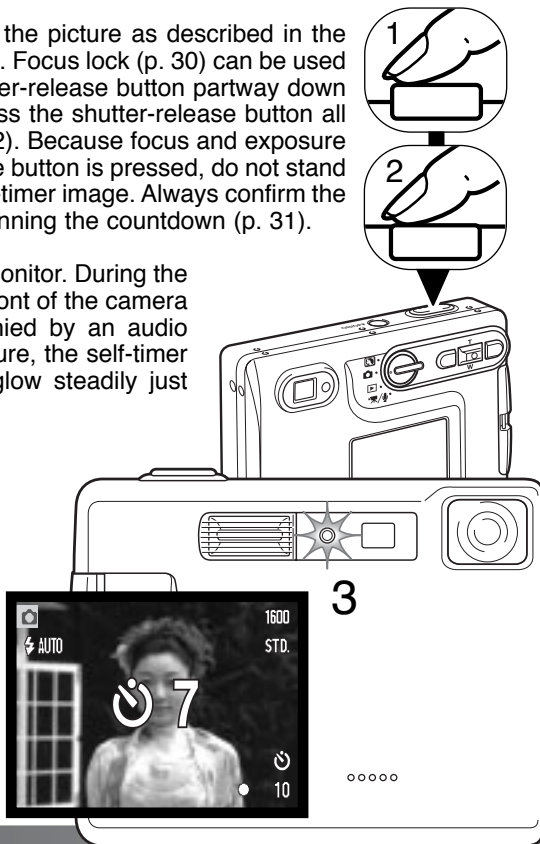

Multi frame



The multi-frame drive mode captures a series of nine consecutive images and lays them out in a single frame. Multi frame is selected in section 1 of the recording-mode menu (p. 43).



Compose the picture as described in the basic recording operation section (p. 27). Press the shutter-release button partway down to lock the exposure and focus for the series. Press the shutter-release button all the way down to begin recording the nine-frame series. Once the series starts, the shutter button can be released; the camera will continue taking pictures until all nine frames have been captured.

Flash can not be used and is canceled automatically. Because of the limits to the shutter speeds in this drive mode, images may be underexposed in low-light conditions. The pixel dimensions set in the image-quality menu option refer to the total area of all nine images, not the size of each individual thumbnail.

IMAGE SIZE AND IMAGE QUALITY

Changing image size affects the number of pixels in each image. The greater the image size, the larger the file size. Choose image size based on the final use of the image - smaller images will be more suitable for web sites whereas larger sizes will produce higher quality prints.

LCD monitor	Number of pixels (hor. X vert.)
2048	2048 X 1536
1600	1600 X 1200
1280	1280 X 960
640	640 X 480

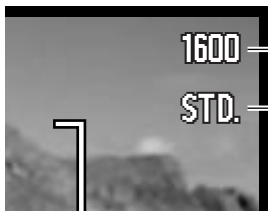

FINE	Fine - high-quality JPEG image.
STD.	Standard - the default setting. (JPEG)
ECON.	Economy - the smallest file sizes. (JPEG)

Image quality controls the rate of compression, but has no effect on the number of pixels in the image. The higher the image quality, the lower the rate of compression and the larger the file sizes. If economical use of the memory card is important, use the economy mode. Standard image quality is sufficient for normal usage. The fine mode will produce the highest quality image and the largest image files.

Image size and quality must be set before the picture is taken. Changes are displayed on the LCD monitor. Image size and quality must be reset manually. Image size and quality are set in section 1 of the recording-mode menu. See navigating the recording mode menu section on page 42.

If image size or quality are changed, the frame counter will display the approximate number of images that can be recorded at that setting on the installed memory card. One memory card can contain images with differing sizes and qualities. The number of images that can be stored on a memory card is determined by the size of the card and the file size of the images. The actual file size is determined by the scene; some subjects can be compressed further than others. See the chart on the following page.

Approximate file sizes.

Quality \ Size	2048 X 1536	1600 X 1200	1280 X 960	640 X 480
Fine	1.6MB	990KB	660KB	210KB
Standard	820KB	520KB	360KB	130KB
Economy	440KB	290KB	210KB	90KB

Approximate number of images that can be stored on a 16MB memory card.

Fine	9	14	22	69
Standard	17	27	39	100
Economy	32	47	69	150

Camera Notes

The frame counter indicates the approximate number of images that can be stored on the memory card at the camera's image quality and size settings. If the settings are changed, the frame counter adjusts accordingly. Because the counter uses approximate file sizes, the actual image taken may not change the counter or may decrease it by more than one. When the frame counter displays zero, it indicates no more images at the image size and quality settings can be captured. Changing those settings may allow more images to be saved to the card.

WHITE BALANCE

White balance is the camera's ability to make different types of lighting appear neutral. The effect is similar to selecting daylight or tungsten film, or using color compensating filters in conventional photography. One automatic and four preset white-balance settings are available with still image and movie recording. White balance is set in section 1 of the recording-mode menu (p. 43) or in section 2 of the movie/audio recording menu (p. 66). When auto reset (p. 55) is active, the white balance will be reset to automatic white balance when the camera is turned off.

The automatic white balance compensates for the color temperature of a scene. In most cases, the auto setting will balance the ambient light and create beautiful images, even under mixed-lighting conditions. When the built-in flash is used, the white balance is set for the color temperature of the flash.



Preset white-balance settings must be set before the image is taken. When one of the preset white-balance settings is selected, an indicator will be displayed on the LCD monitor to indicate the active white-balance setting; the effect is immediately visible on the monitor. To record the ambient light, set the flash mode to flash cancel (p. 32). The built-in flash can be used with preset white-balance, but will create a pinkish or blueish cast with the fluorescent and tungsten settings. The flash is daylight balanced and will produce good results with the daylight and cloudy settings.



Daylight - for outdoor and sunlit subjects.



Cloudy - for overcast outdoor scenes.



Tungsten - for incandescent lighting: household filament light bulbs.



Fluorescent - for fluorescent lighting: office ceiling lights.

CUSTOMIZING KEY FUNCTIONS

Initially in the recording mode, exposure compensation is adjusted with the left/right keys of the controller, see page 40. The function adjusted with these keys can be changed in section 1 of the recording-mode menu. This function does not affect the movie recording mode.

Select the key func. option in section 1 of the recording mode menu. Use the up/down keys to select the function (1). Press the central controller button to set the function (2). The selected function will now be activated when the left/right controller keys are pressed in the recording mode.

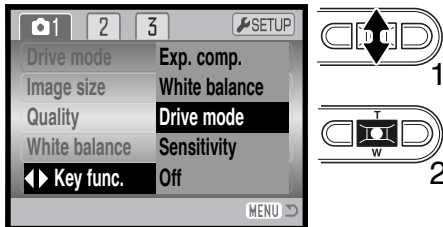

Refer to the following sections for information on the drive mode (p. 44), white balance (p. 50), and camera sensitivity (p. 52). For information on exposure compensation and the use of the left/right keys for making settings, see page 40.

CAMERA SENSITIVITY - ISO

Four camera sensitivity settings can be selected with a still image: Auto, 50, 100, 200, 400; the numerical values are based on an ISO equivalent. ISO is the standard used to indicate film sensitivity: the higher the number, the more sensitive the film. Sensitivity can be changed in section 2 of the recording-mode menu (p. 43).

The auto setting automatically adjusts the camera sensitivity to the light conditions between ISO 50 and ISO 160. When any other setting than auto is used, “ISO” and the set value will appear on the LCD monitor.

A specific sensitivity setting can be selected. As the ISO value doubles, the camera sensitivity doubles. Like grain in silver-halide film that increases with speed, noise increases with the sensitivity in digital imaging; an ISO setting of 50 will have the least noise and 400 will have the most.



FLASH RANGE AND CAMERA SENSITIVITY

Because of the optical system, the flash range is not the same at the lens' wide-angle position as it is at the telephoto position.

ISO setting	Flash range (wide angle)	Flash range (telephoto)
AUTO	0.15m ~ 3.2m (0.5ft. ~ 10.5ft)	0.15m ~ 2.5m (0.5ft. ~8.2ft)
50	0.15m ~ 1.8m (0.5ft. ~ 5.9ft)	0.15m ~ 1.4m (0.5ft. ~4.6ft)
100	0.15m ~ 2.5m (0.5ft. ~8.2 ft)	0.15m ~ 2.0m (0.5ft. ~6.6ft)
200	0.15m ~ 3.6m (0.5ft. ~11.8 ft)	0.15m ~ 2.8m (0.5ft. ~9.2ft)
400	0.15m ~ 5.1m (0.5ft. ~16.7 ft)	0.15m ~ 4.0m (0.5ft. ~13.1ft)

METERING MODES

The icons indicating the metering modes are displayed on the monitor. The metering mode is set in section 2 of the recording mode menu (p. 43).

Multi-segment metering: uses 256 segments to measure luminance and color. This data is combined with distance information to calculate the camera exposure. This advanced metering system will give accurate worry-free exposures in almost all situations.

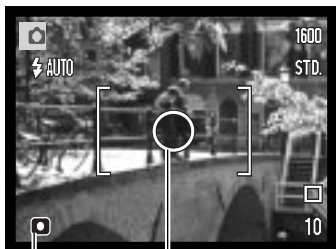

Spot metering: uses a small area within the image to calculate the exposure. When this mode is selected, the LCD monitor will automatically activate if off and a small circle will appear in the middle of the live image indicating the measuring area. The spot allows precise exposure measurements of a particular object without being influenced by extremely bright or dark areas within the scene. If the LCD monitor is turned off, the spot-metering mode will remain active.

Spot-metering area

Spot-metering indicator

COMPENSATING EXPOSURE WITH THE MENU

Exposure compensation increases or decreases the exposure by as much as 2 Ev. For information on exposure compensation, see page 41. Exposure compensation can also be set with the left/right keys of the controller, see above and page 40.

Select the exposure compensation option in section 2 of the recording mode menu. Use the up/down keys to adjust the degree of compensation (1). Press the central controller button to set this value (2). If any value other than 0.0 is set, an indicator will be displayed on the monitor as a warning.



NOISE REDUCTION

This function reduces the affect of dark noise caused by long exposures. Noise reduction is only applied to exposures of one second or longer. Processing is applied to each image after it is captured. The processing time varies from image to image; a message will be displayed during this period.

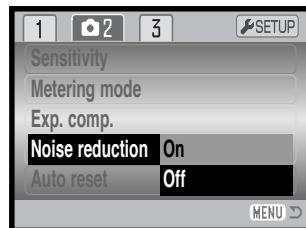

AUTO RESET

When auto reset is active, the following functions return to their program setting when the camera is turned off. Auto reset is initially on. This function can be turned off in section 2 of the recording-mode menu (p. 43).

Flash mode (p. 32) – Auto
Drive mode (p. 44) – Single frame advance
White balance (p. 50) – Auto
Camera sensitivity (p. 52) – Auto
Exposure compensation (p. 40) – 0.0 Ev
Metering mode (p. 53) – Multi segment
Color mode (p. 56) – Color
AF area (p. 61) – Wide focus frame
LCD monitor display (p. 34) – Full display

The flash mode is reset to autoflash with red eye reduction if autoflash with red eye reduction was last set, if not the mode will be reset to autoflash. See page 32 for information on flash modes.

Camera Notes

The camera will reset if the battery is removed for an extended period. An internal battery protects the clock, calendar, and camera settings for more than 24 hours if the camera is used for at least 5 minutes before the battery is removed.

COLOR MODE

The color mode controls whether a still image is color or black and white. This must be set before the image is recorded. The color mode is set in section 3 of the recording mode menu (p. 43) or in section 2 of the movie/audio recording menu (p. 66). The live image on the monitors will reflect the selected color mode. The color option uses no monitor indicator when active. The color mode has no effect on image file size.

The **black & white** mode produces neutral monochrome images. **Sepia** creates warm-tone monochrome images.

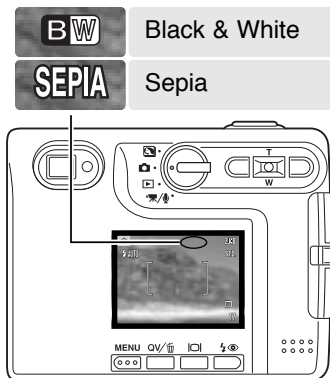

VOICE MEMO



Voice memo allows an audio track up to fifteen second to be recorded with a still image. The function is activated in section 3 of the recording-mode menu (p. 43). When the function is active, the microphone indicator is displayed on the LCD monitor. The voice memo must be set before taking a picture. It will remain in effect until reset. When the LCD monitor is turned off (p. 34), it will automatically activate for the voice-memo period.

After an image is captured, a screen will appear indicating the audio recording has started. A bar graph (1) will display the amount of recording time remaining.



Remaining recording time

To stop the recording, press the shutter-release button or the center button of the controller (2). The recording will automatically stop when the fifteen-second limit has elapsed.

Voice memo is attached to the last image of a continuous-advance series (p. 45). When played back, images with voice-memo audio tracks have a note icon displayed with them (p. 68). In section 1 of the playback mode menu, a voice memo attached to an image can be deleted (p. 73).

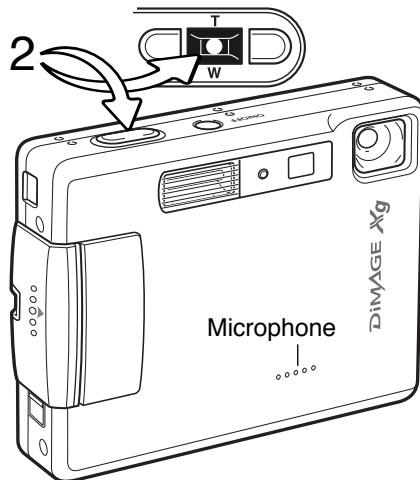

Camera Notes

When making audio recordings, be careful not to touch or cover the microphone. The quality of the recording is proportional to the subject to microphone distance. For best results, hold the camera approximately 20cm (8in) from your mouth.

DATE IMPRINTING

The date and time of recording can be printed directly on the image. The imprinting function must be activated before the image is taken. Once activated, the date will continue to be imprinted until the function is reset; a yellow bar is displayed behind the frame counter on the monitor to indicate the imprinting function is active.



Date-imprinting indicator

Date imprinting is activated with section 3 of the recording-mode menu (p. 43). Date imprinting has two menu options. The YYYY/MM/DD option prints the date. The MM/DD/hr:min option prints the month, day, and time of recording.

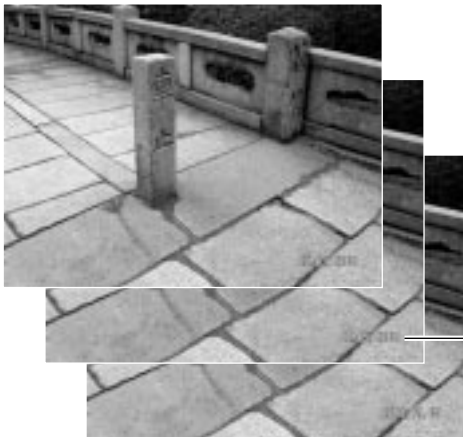

The date and time are imprinted in the lower right corner of the image when viewed horizontally. It is printed directly on the photograph writing over the image information. The date can be imprinted in three formats: year / month / day, month / day / year, and day / month / year. The date and date format are set in section 3 of the setup-mode menu (p. 98).

Camera Notes

Every time a still image is recorded, it is stored with an exif tag that contains the date and time of recording as well as shooting information. This information can be viewed with the camera in the Quick View or playback mode, or on a computer with the DiMAGE Viewer software.

DIGITAL ZOOM

The digital zoom is activated in section 3 of the recording-mode menu (p. 43). The digital zoom increases the magnification of the greatest telephoto setting of the optical zoom by up to 4X in 0.1X increments. Although the images recorded with the digital zoom are interpolated to the set image size, the quality of the images may not be equal to images taken without the digital zoom; the greater the power of the digital zoom the lower the image quality. The effect of the digital zoom is visible on the LCD monitor only. The digital-zoom function is canceled if the LCD monitor is turned off (p. 34).

At the maximum telephoto position, press the up key of the controller to engage the digital zoom. The zoom magnification will be displayed in the top right corner of the monitor.

To zoom out, press the down key of the controller.

When the digital zoom is active, the focus frame changes size.

While zooming, the zoom indicator is displayed on the LCD monitor to show the approximate zoom position.

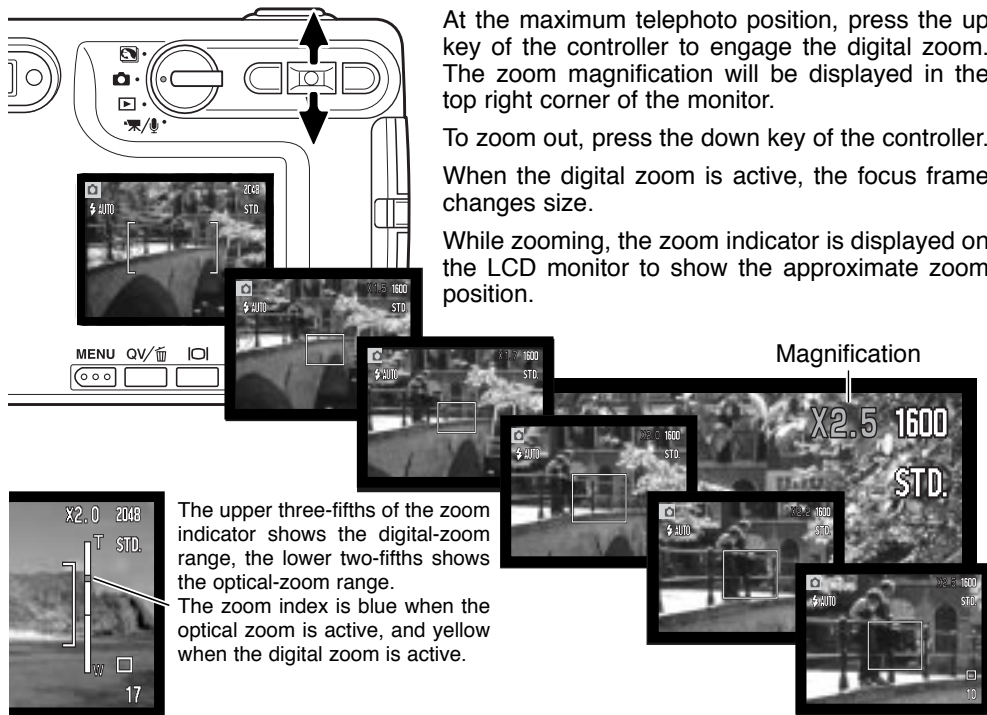

INSTANT PLAYBACK

After a still image is captured, it can be displayed on the monitor for two seconds before being saved. Instant playback shows the last frame in the series when used with the continuous-advance drive mode (p. 45). When the LCD monitor is turned off (p. 34), it will automatically activate for the instant playback period.

Instant playback can be activated in section 3 of the recording-mode menu (p. 42). When used with voice memo, the audio recording will begin after the image is played back.

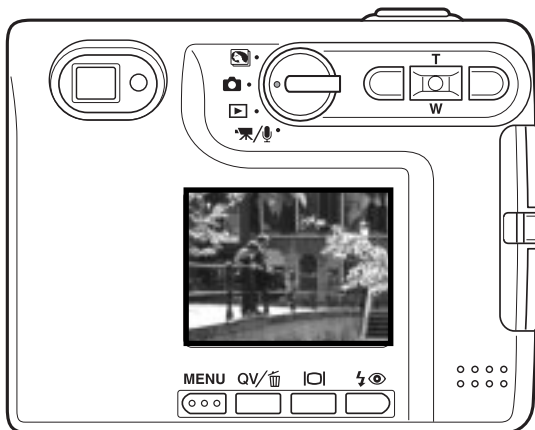

Camera notes

Images can be previewed immediately after they have been captured regardless if instant playback is active or not. Simply continue to hold down the shutter-release button after taking the picture to display the image on the monitor. Release the shutter button to end the playback. This function is disabled if the monitor is turned off or the continuous advance or the self-timer drive mode is used.

SPOT AF

The spot AF is used for selective focusing. Both focus and exposure are determined with the spot focus area. When auto reset (p. 55) is active, the spot AF area will reset to the wide focus frame when the camera is turned off. The spot focus area can be used with movie recording. When used with the digital zoom (p. 59), spot focus area is enlarged.



Press and hold the center button of the controller (1) to display the spot focus area; the center button switches between the spot and wide AF areas.

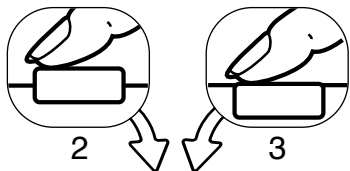

Place the subject inside the spot focus area (2) and pressing the shutter-release button partway down to lock the focus and the exposure. Focus lock (p. 30) is active for off-center compositions. The focus signals (p. 31) will confirm the image is in focus. Press the shutter release button all the way down to take the picture (3).

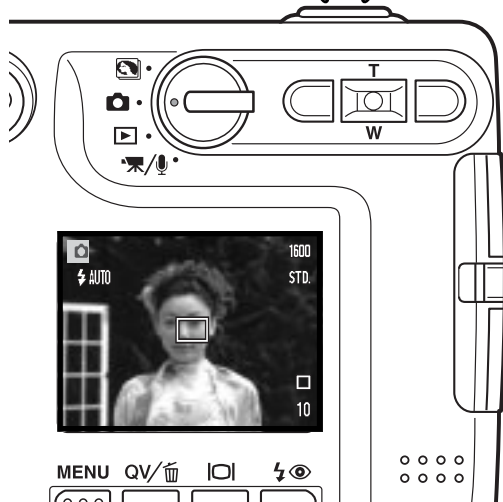

When the LCD monitor is off, the camera cannot be switched between wide and spot AF; the last AF mode set will be active. When the live image only display is used, switching between the wide and spot AF modes resets the display mode to full.

RECORDING WITHOUT A MEMORY CARD

If no memory card is installed in the camera, a single still image can be recorded and saved in the camera's buffer memory. Only the last image captured is stored; each time an image is captured, it replaces the image data saved in the buffer. If the mode dial is turned to another position or the camera is turned off, the image data is deleted from the buffer memory. Quick View can be used to preview the image. Voice memo cannot be used.

MOVIE AND AUDIO RECORDING

MOVIE RECORDING

This camera can record digital video with sound. Total recording time varies with the image size and the memory card capacity, see the navigating the movie menu section on page 65. In movie recording, some functions can be used, some are fixed, and some are disabled, see the notes section on page 67.



Set the mode dial to the movie/audio recording position.

Place the subject in the focus frames and press the shutter-release button partway down to lock focus (1). Press the shutter-release button all the way down and release to begin recording (2).

The camera will continue to record until the recording time is used or the shutter-release button is pressed again.

When recording, the frame counter will display the elapsed time. During the last ten seconds, the counter will turn red and count down the time.

Take care not to cover the microphone while recording.

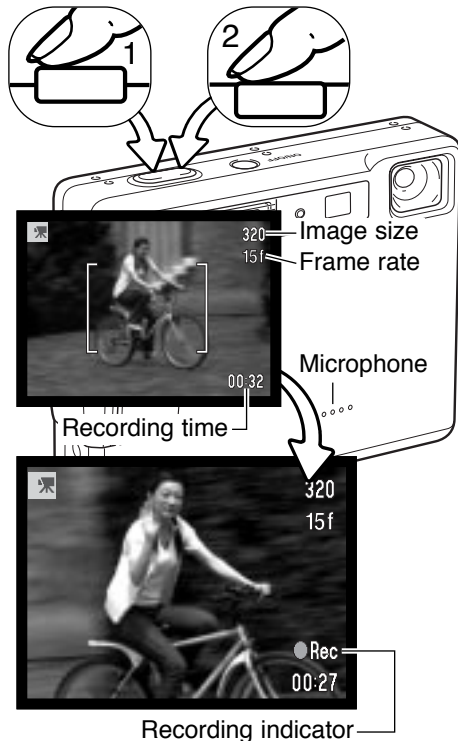

AUDIO RECORDING

Audio can be recorded without an image. About 30 minutes of audio can be stored on a 16MB memory card. Audio is recorded at approximately 8KB/s. A maximum of 180 minutes can be recorded at one time; the optional AC adapter set AC-401/501 is required for long recordings.

Turn the mode dial to the movie/audio recording position. On the movie/audio menu, change the recording mode to audio. See page 66 for details on menu operation.

The audio recording mode uses a blue screen. In stand-by, the monitor shows the approximate recording time available.

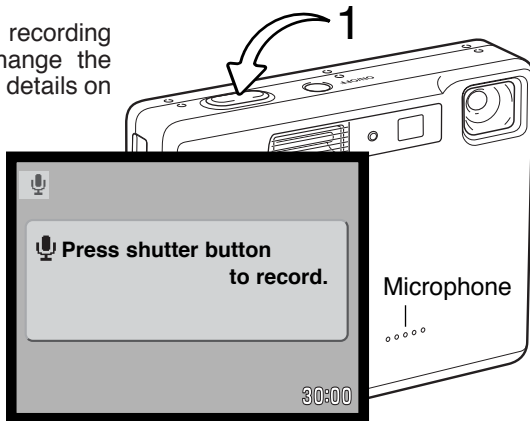

To begin recording, press and release the shutter button (1). The frame counter will display the elapsed time; during the last ten seconds, the counter will turn red and count down the time. The recording will stop when the shutter-release button is pressed again or the remaining time has elapsed.

When making audio recordings, be careful not to touch or cover the microphone. The quality of the recording is proportional to the subject to microphone distance. For best results, hold the camera approximately 20cm (8in) from your mouth.



NAVIGATING THE MOVIE/AUDIO RECORDING MENU

Navigating the menu is simple. The menu button turns the menu on and off. The left/right and up/down keys of the controller control the cursor and change settings on the menu. Pressing the center button of the controller selects menu options and sets adjustments.

MENU



To activate the movie/audio recording-mode menu, press the menu button.

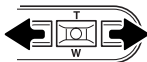

The section 1 tab at the top of the menu will be highlighted. Use the left/right keys to highlight the appropriate menu tab; the menus will change as the tabs are highlighted.



When the desired menu section is displayed, use the up/down key to scroll through the menu options. Highlight the option whose setting needs to be changed.

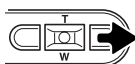

With the menu option highlighted, press the right key; the settings will be displayed with the current setting highlighted. To return to the menu options, press the left key.



Use the zoom lever to highlight the new setting.

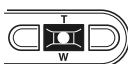

Press the center button of the controller to select the highlighted setting.

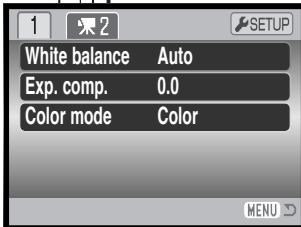
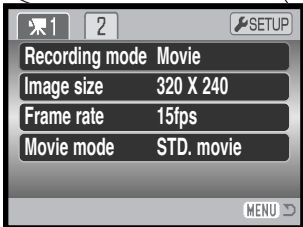
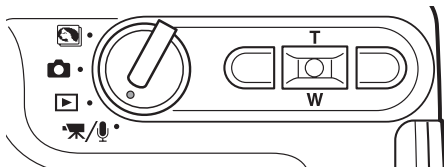

Once a setting has been selected, the cursor will return to the menu options and the new setting will be displayed. Changes can continue to be made. To return to the movie/audio recording mode, press the menu button.

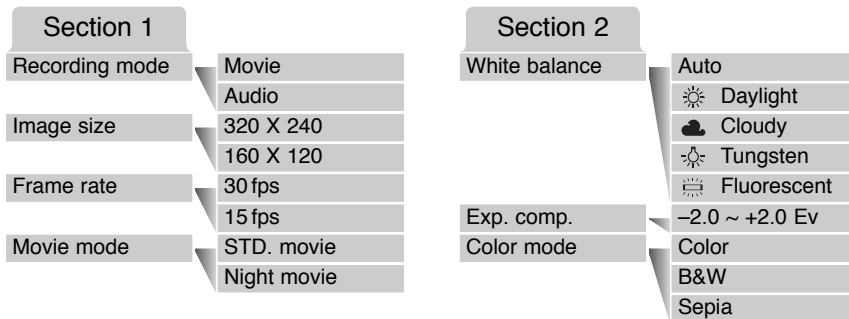

Recording mode: The recording mode option switches between recording movie clips or audio.

Image size: Movies can be recorded at two sizes: 320x240 and 160x120. The larger the image size, the higher the image quality and the larger the file sizes. Image size is set in section 1 of the movie menu.

Frame rate: Movies can be recorded at two frame rates: 15 fps and 30 fps. The higher the frame rate, the smoother the moving image and the larger the file sizes. Frame rate is set in section 1 of the movie menu.

Movie mode: The movie mode option selects the type of movie recorded. Standard produces a normal movie clip. Night Movie uses high camera sensitivity to record under low light levels; camera sensitivity is automatically increased in low light. Image quality can be lower with Night Movies because of the higher sensitivity. The movie mode is set in section 1 of the movie menu.

For information on white balance, see page 50. See page 40 for information on exposure compensation, and see page 56 for the color mode. Any changes to these three options will also affect the recording mode.

MOVIE FILE SIZES

If image size or frame rate is changed, the frame counter will display the approximate number of seconds that can be recorded at that setting on the installed memory card. One memory card can contain movie clips with differing sizes and frame rates. The total time that can be stored on a memory card is determined by the size of the card and the recording rate. The actual file size is determined by the scene; some subjects can be compressed further than others.

Approximate recording rate		
Frame rate	Image size	
		320 X 240
30 frames per second	670KB/s	160KB/s
15 frames per second	340KB/s	85KB/s
Approximate number of seconds that can be stored on a 16MB memory card.		
30 frames per second	21 seconds	82 seconds
15 frames per second	41 seconds	150 seconds

NOTES ON MOVIE RECORDING

In movie recording, some functions can be changed with the movie menu (p. 66). Exposure, focus, and camera sensitivity are automatic. Both the wide focus frames and the spot focus area can be selected. Quick View can be used. The display button switches between the full display and the live image only. The flash is disabled. When the red low-battery indicator appears (p. 16), power is insufficient for movie recording.

The optical and digital zoom are active. A 4X digital zoom can be used during recording when the frame rate is set to 15fps.

Depending on the image size and frame rate, the writing speed of the memory card in use may prematurely end the recording of a movie clip, especially with 320 X 240 size images at 30 frames per second. Test the card before important events.

PLAYBACK - ADVANCED OPERATION

The basic functions in this mode are described in the basic playback section on pages 36 through 39. This section covers how to playback movie clips and audio tracks as well as the advanced function on the playback menu.

PLAYING BACK VOICE MEMOS AND AUDIO CAPTIONS



Voice memos (p. 56) and audio captions (p. 70) can be played back in Quick View and the playback mode. When one of these audio tracks is attached to a still image, the audio-track indicator will be displayed at the bottom of the monitor.

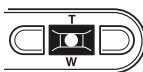

Press the central button of the controller to start the audio playback.



Playback time is displayed at the top of the image. The display will return to Quick View or the playback mode when the audio track finishes.



During playback, the up/down keys of the controller adjust the volume.



Press the menu button to cancel the playback.

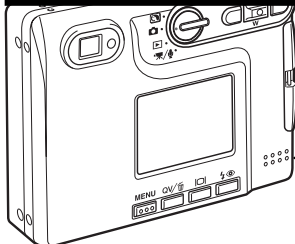

Speaker

PLAYING BACK MOVIES AND AUDIO RECORDINGS

Movie clips and audio recordings are played back the same way. Use the left/right keys of the controller to display the movie or audio file; audio files are displayed with a blue screen.



Audio file

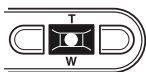

Press the center of the controller to play back a movie or audio file.

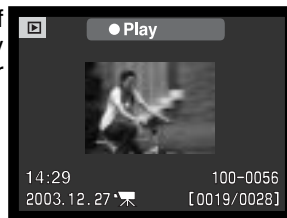

Movie file

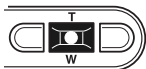

Press the controller to pause the movie or audio playback; press the controller again to resume the playback.



During playback, the up/down keys adjust the volume and the left/right keys rewind and fast forward the recording.



Press the display button to view the movie with or without the guidance bar.

To cancel the playback, press the menu button.

NAVIGATING THE PLAYBACK-MODE MENU

Navigating the menu is simple. The menu button turns the menu on and off. The left/right and up/down keys of the controller control the cursor and change settings on the menu. Pressing the center button of the controller selects menu options and sets adjustments.

MENU



To activate the playback menu, press the menu button.

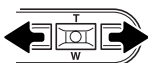

The section 1 tab at the top of the menu will be highlighted. Use the left/right keys to highlight the appropriate menu tab; the menus will change as the tabs are highlighted.



When the desired menu section is displayed, use the up/down key to scroll through the menu options. Highlight the option whose setting needs to be changed.

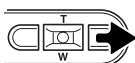

With the menu option highlighted, press the right key; the settings will be displayed with the current setting highlighted. If “Enter” is displayed, press the center button to display the setting screen.



Use the zoom lever to highlight the new setting.

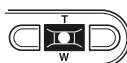
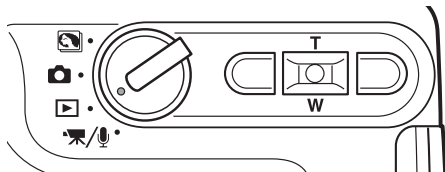

Press the center button of the controller to select the highlighted setting.

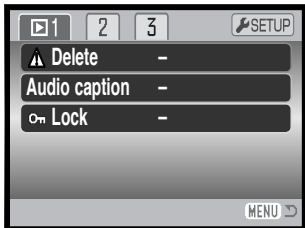

Once a setting has been selected, the cursor will return to the menu options and the new setting will be displayed. Changes can continue to be made. To return to the recording mode, press the menu button.

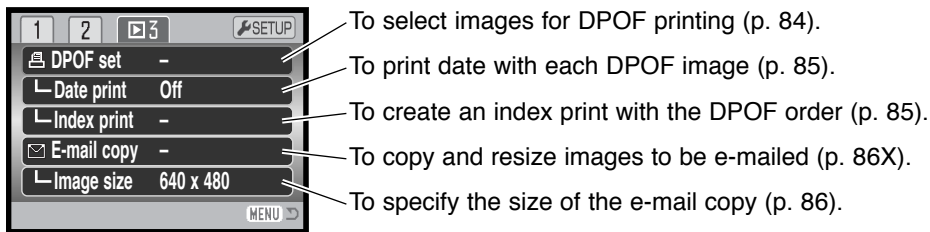
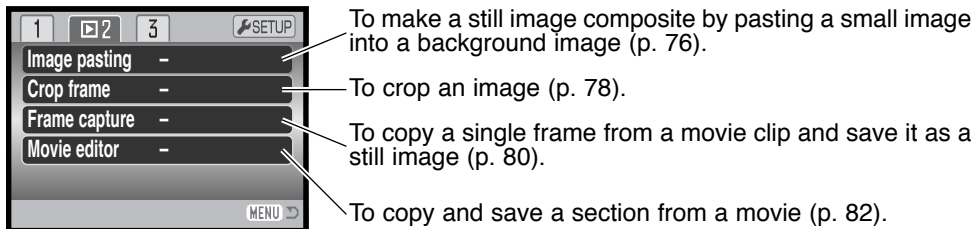
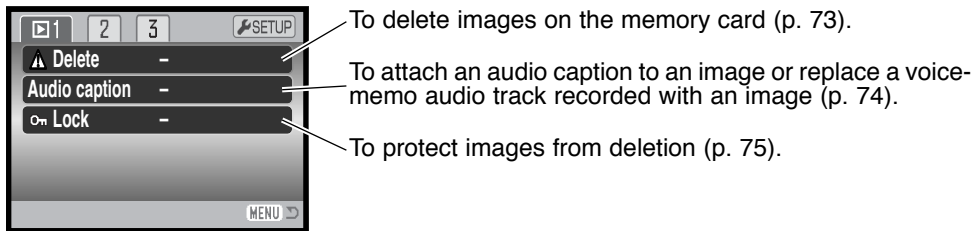

Refer to the following sections for details on the menu options and their settings.

FRAME-SELECTION SCREEN

When a marked-frames setting is chosen on the menu, the frame selection screen will appear. This screen allows multiple image and audio files to be chosen.

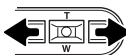
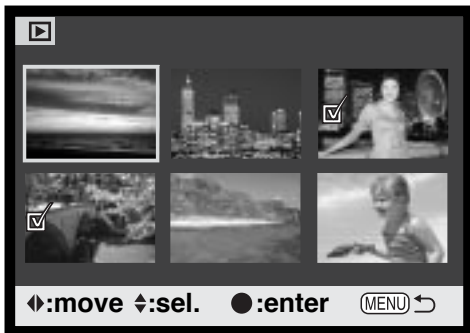





The left/right keys of the controller move the yellow border to select the image.



The up key of the controller selects the frame; when selected, an indicator will appear next to the image. The down key will deselect the image removing the indicator.



The menu button cancels the screen and any operation made.

-  The garbage-can icon indicates the image is selected for deletion.
-  The key icon indicates the image is locked or selected to be locked.
-  The printer icon indicates the image is selected for DPOF printing. The number of copies is shown on the right.
-  The check icon indicates the image is selected to be copied.

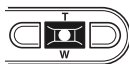

Press the central button of the controller to complete the operation.

Indicators may be displayed on the right of each index image to indicate movie, audio, and E-mail copy files.



DELETING IMAGE AND AUDIO FILES



Deleting permanently erases the file. Once deleted, a file cannot be recovered. Care should be taken when deleting images.

Single, multiple, or all files on the memory card can be deleted in section 1 of the playback-mode menu (p. 71). The delete option has four settings:

This frame	The file displayed or highlighted in playback mode will be deleted.
Audio track	The voice-memo or audio caption attached to the image will be deleted.
All frames	All unlocked files will be deleted.
Marked frames	To delete multiple files. When this setting is chosen, the frame-selection screen will be displayed. Use the left/right keys of the controller to highlight the first file to be deleted. Pressing the up key will mark the thumbnail with the garbage-can icon. To deselect a file for deletion, highlight it with the yellow border and press the down key; the garbage-can icon will disappear. Continue until all the files to be deleted are marked. Press the central button of the controller to continue (the confirmation screen will appear), or press the menu button to cancel the operation and return to the playback menu. On the confirmation screen, highlighting and entering “Yes” will delete the marked files.

Before a file or voice-memo/audio caption is deleted, a confirmation screen appears. Choosing “Yes” executes the operation, “No” cancels it.

The file must be unlocked to use the delete function. Locked files must be unlocked before they can be deleted.



AUDIO CAPTION

A still image can have a fifteen-second audio caption attached to it. This function will also replace a voice-memo audio track recorded with an image. Audio captions cannot be attached to movie clips, nor can they over rewrite audio recordings.



Display the image to which the audio caption will be attached. If the image is locked, unlock it using section 1 of the playback menu (p. 75).



On the playback menu, highlight the **Enter** setting in the audio-caption option.

Press the central button of the controller (1) to start recording. If an audio track is already attached to the image, a confirmation screen will appear. Choosing and entering “Yes” will start the audio caption recording replacing the previous audio track. “No” will cancel the audio-caption operation.

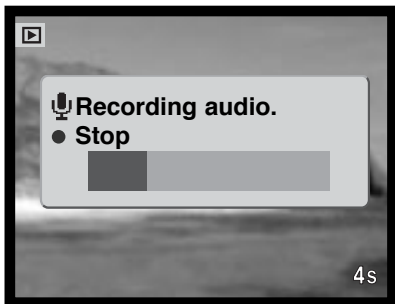
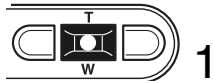

A status bar and the frame counter displays the remaining recording time. The audio caption can be stopped during the fifteen-second recording period by pressing the central button of the controller (1).

LOCKING IMAGE AND AUDIO FILES

Single, multiple, or all files can be locked. A locked file cannot be deleted by either the playback-mode menu functions or the QV/delete button. However, the formatting function (p. 91) will erase all files on a memory card whether locked or not. Important images and audio recordings should be locked. The lock function is in section 1 of the playback menu (p. 71). The lock option has four settings:

This frame	The file displayed or highlighted in playback mode will be locked.
All frames	All files on the memory card will be locked.
Marked frames	To lock or unlock multiple files. When this setting is chosen, the frame-selection screen will be displayed. Use the left/right keys of the controller to highlight the file to be locked. Pressing the up key will mark the file with the key icon. To unlock a file, highlight it with the yellow border and press the down key; the key icon will disappear. Continue until all the files to be locked are marked. Press the central button of the controller to lock the marked thumbnails, or press the menu button to cancel the operation and return to the playback menu.
Unlock all	All files on the memory card will be unlocked.

IMAGE PASTING

Image pasting makes a still image composite by pasting a small image into a background image. The composite image has the same image size and quality as the background image.

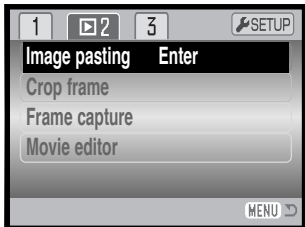

The image-pasting option of in section 2 of the playback menu offers the choice of frame type and size as well as where to place the pasted image. Display the background image on the LCD monitor. Select image pasting in the playback menu and press the center button to start the pasting process.

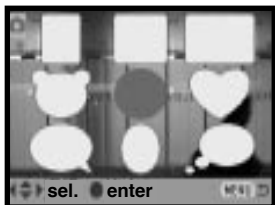

Nine frame choices are shown on the LCD monitor. Select the frame with the controller. Press the center button to continue.

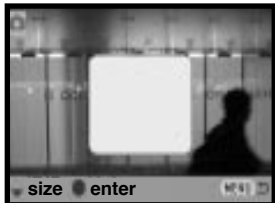

The frame is displayed on the background image. Change the frame size using the up and down keys; three sizes are available. Press the center button to continue.

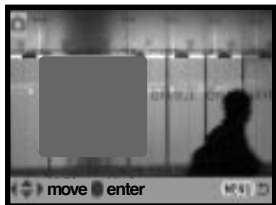

Choose the location for the pasted image by moving the frame with left/right and up/down keys. Press the center button to continue.

Pressing the menu button cancels pasting operation and returns to the playback mode. The camera memorizes the settings made.

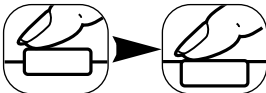

A live image is displayed in the frame. Compose the subject inside the frame and press the shutter-release button partway down to lock the focus. Previous recording mode settings are used to capture the image and the optical zoom can be used. Press the shutter-release button all the way down to take the picture and complete the operation.

CROPPING FRAMES

A portion of a still image can be copied and saved.

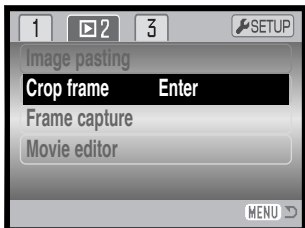

Display the image to be cropped on the LCD monitor. Select the crop-frame option in section 2 of the playback menu and press the center button to start the cropping process.

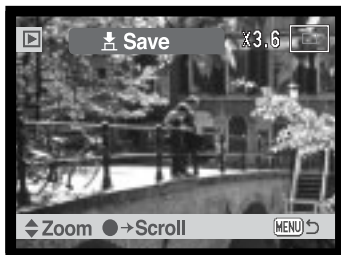

Display the image to be cropped. Press the up key of the controller to enlarge the image. The degree of magnification is displayed on the LCD monitor. Pressing the up key increases the image magnification. Pressing the down key decreases the image magnification.

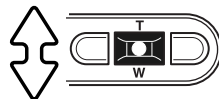

To scroll the image, press the center button of the controller. The center button switches between the zoom and scroll screens.



Use the left/right and up/down keys of the controller to scroll the image.



Repeat the zoom and scroll operations to display the image area to be cropped. The minimum image size that can be cropped is 320 X 240.



When the image area to be cropped is displayed, press the shutter-release button all the way down to complete the crop.

Saved as PICT0015.JPG.

OK

The file name of the cropped image is displayed. Press the center button of the controller to complete the operation.

The cropped image has the same image quality as the original image. Voice-memos and audio captions will not be copied to the cropped image. Cropped files of locked images are unlocked.

FRAME CAPTURE

A single frame from a movie clip can be copied and save as a still image. The copied image has the same image size as the original movie.

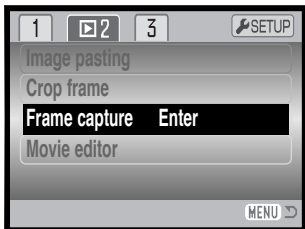

In the playback mode, use the left/right keys of the controller to display the movie.

Select the frame-capture option in section 2 of the playback menu and press the center controller button to start the capture process.



The selected movie file is loaded into the camera buffer memory and the first frame of the movie is displayed.

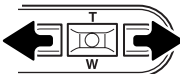

Press the left/right keys of the controller to display the frame to be captured.

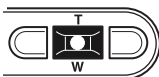

Press the center button of the controller to capture the frame. Before the frame is captured, a confirmation screen appears. Choosing “Yes” executes the operation, “No” cancels it.

When “Yes” is selected the save-audio confirmation screen is displayed.



Choosing “Yes” records the movie sound track and saves it as an audio-capture WAV file. The sound is taken from approximately 7.5 seconds before and after the point of the captured frame. Selecting “No” records no sound track.

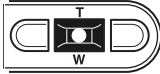

When saved, the file names of the captured image and sound track are displayed. Press the center button of the controller to complete the operation.

MOVIE EDITOR

A section from a movie clip can be copied and save. The copied image has the same image size as the original movie.



In the playback mode, use the left/right keys of the controller to display the movie.

Select the movie-editor option in section 2 of the playback menu and press the center button to start the editing process.

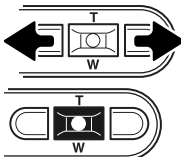

The selected movie file is loaded into the camera buffer memory and the first frame of the movie is displayed.

Press the left/right keys of the controller to display the first frame of the edit. Press the center button of the controller to continue.

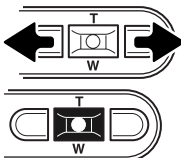

Use the left/right keys of the controller to display the last frame of the edit. Press the center button of the controller to continue; the preview-clip message is displayed.

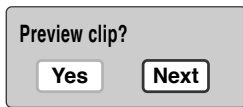

Choosing “Yes” plays back the edited movie. The same confirmation screen is displayed after playback. Choose “Next” to continue; the save-clip message is displayed.

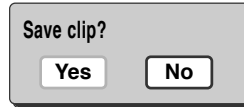

Choosing “Yes” saves the edited movie, “No” cancels the operation.

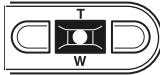

When saved, the file name of the edited movie is displayed. Press the center button of the controller to complete the operation.

The length of the edited section depends on the image size and the frame rate of the original movie. Refer to the table below.

Image size	Frame rate	Maximum time of edit
320 X 240	30 fps	10 sec.
	15 fps	19 sec.
160 X 120	30 fps	41 sec.
	15 fps	76 sec.

ABOUT DPOF

This camera is supported by DPOF™. The DPOF (Digital Print Order Format) allows direct printing of still images from digital cameras. After the DPOF file is created, the memory card is simply taken to a photofinishing service or inserted into the memory-card slot of DPOF compatible printers. When a DPOF file is created, a misc. folder is automatically created on the memory card to store it (p. 106).

CREATING A DPOF PRINT ORDER

The DPOF-set menu option is used to create an order for standard prints from still images on the memory card. Single, multiple, or all images can be printed. Print orders are created in section 3 of the playback-mode menu (p. 71). The print menu option has four settings:

This frame	To create a DPOF file for the displayed or highlighted image.
All frames	To create a DPOF file for all images on the memory card.
Marked frames	To chose a group of images to be printed or when the number of copies of each image varies. When selected, the frame selection screen will appear. Use the left/right keys of the controller to highlight an image to be printed. Pressing the up key will mark the image with the printer icon. The number next to the icon indicates the number of copies that will be printed. Pressing the up key will increase the number of copies, pressing the down key will decrease the number. A maximum of nine copies can be ordered. To deselect an image for printing, press the down key until the number of copies reaches zero and the printer icon disappears. Continue until all the images to be printed are marked. Press the central button of the controller to create the DPOF file, or press the menu button to cancel the operation and return to the playback menu.
Cancel all	To delete the DPOF file.

When the **this-frame** or **all-frames** setting is chosen, a screen will appear requesting the number of copies of each image; a maximum of nine copies can be ordered. Use the up/down keys of the controller to set the required number of copies. If the **all-frames** setting was used to create a print order, any additional images recorded afterwards will not be included in the order.

DPOF files created with another camera will be canceled. After the pictures have been printed, the DPOF file will still remain on the memory card and must be canceled manually.

DATE PRINT / INDEX PRINT

To print the date with each image in the DPOF order, select “On” in the date-print option in section 3 of the playback-mode menu. To cancel the date print, change the setting to “Off.”

To create an index print of all the images on the card, select “Yes” in the index-print option in section 3 of the playback-mode menu. To cancel the index print, simply change the setting to “No.”

If the date-print option is set to “On” or an index-print order is created, any additional images saved afterwards on the card will not be affected by the menu command. The menu options must be selected again.

The number of images printed per sheet differs between printers. The information printed with the thumbnails can vary.

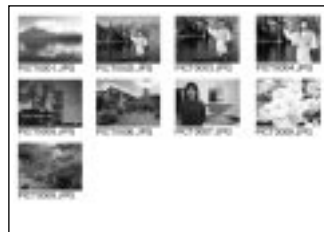

Index Print

Camera Notes

DPOF files and images can be printed directly from the camera, see page 110.

E-MAIL COPY

E-mail Copy makes a standard 640 X 480 (VGA) or 160 X 120 (QVGA) JPEG copy of an original still image so that it may be easily transmitted by e-mail. If an economy image is selected for E-mail Copy, the image quality will not change. E-mail copies are saved to the original card. The copy function is selected in section 3 of the playback-mode menu (p. 71).

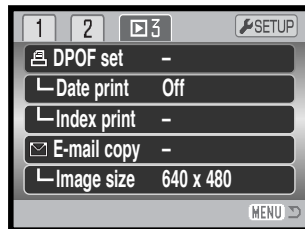

When the copy function is used, a folder is created for the files (p. 106); copy folder name ends in **EM**. Images with voice memos are copied with their audio files. Copies of locked images are unlocked. DPOF information is not copied.

The amount of data can be converted into E-mail copies depends on the free space remaining on the memory card and the image size of the copy. The E-mail copy function has two menu options:

This frame	To copy the file displayed or highlighted in playback mode.
Marked frames	To copy single or multiple files. When selected, the frame-selection screen will appear; highlight the file to be copied with the yellow border and then press the up key of the controller to mark it with the check icon. To deselect a file to be copied, highlight the selected thumbnail and press the down key; the check icon will disappear. Continue until all the files to be copied are marked. Press the central button of the controller to continue, or press the menu button to cancel the operation and return to the playback menu.

Before starting the E-mail copy routine, select the image size of the copy in section 3 of the playback menu (p. 71). Two sizes are available: 640 X 480 (VGA) or 160 X 120 (QVGA).

Copied to 102KM_EM

OK

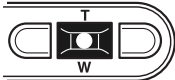

When the image(s) to be converted to an e-mail file are selected, the copy routine will begin and a screen will appear indicating the name of the folder containing the copied images; press the central button of the controller to return to the menu. The same folder is used to store e-mail copies until the number of images exceed 9,999.

Camera Notes

The copy-unsuccessful message will appear when one or all of the images could not be copied. Check the memory card to see which files were copied and then repeat the procedure for the uncopied images.

SETUP MODE

The setup menu is used to control the camera's functions and operation. The navigating the setup menu section covers the operation of the menu. The section is followed by detailed descriptions of the settings.

OPENING THE SETUP MENU

The setup menu is opened from the other menus. It can be accessed from any of the recording or playback menus.

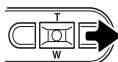
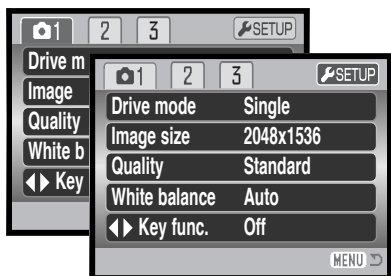

Use the right key to highlight the setup tab at the top of the menu.

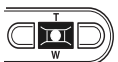

Press the central button to open the setup menu.

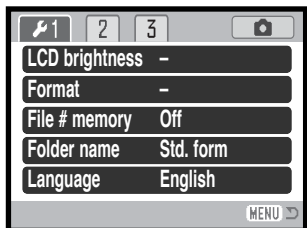

Setup menu

Reverse the procedure to return to the original menu. Pressing the menu button closes the menu and returns to the recording or playback modes.

NAVIGATING THE SETUP MENU

Navigating the menu is simple. The left/right and up/down keys of the controller control the cursor and change settings on the menu. Pressing the center button of the controller selects menu options and sets adjustments.

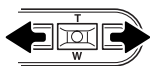

The section 1 tab at the top of the menu will be highlighted. Use the left/right keys to highlight the appropriate menu tab; the menus will change as the tabs are highlighted.



When the desired menu section is displayed, use the up/down key to scroll through the menu options. Highlight the option whose setting needs to be changed.

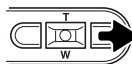

With the menu option highlighted, press the right key; the settings will be displayed with the current setting highlighted. If “Enter” is displayed, press the center button of the controller to continue.



Use the zoom lever to highlight the new setting.

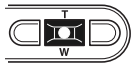

Press the center button of the controller to select the highlighted setting.

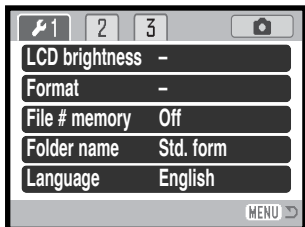

Once a setting has been selected, the cursor will return to the menu options and the new setting will be displayed. Changes can continue to be made. To return to the recording mode, press the menu button.

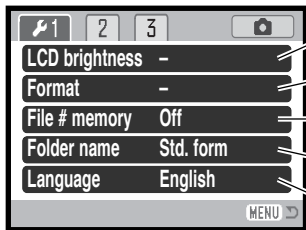

- To set monitor brightness (p. 91).
- To format the memory card (p. 91).
- To activate file number memory (p. 92).
- To select the folder name format (p. 92).
- To set the menu language (p. 93).

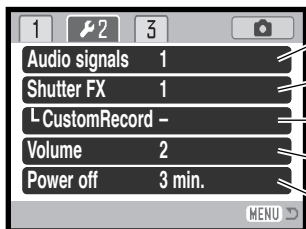

- To change or turn off audio signals (p. 93).
- To change or turn off the shutter sound effect (p. 93).
- To record a personalized sound effect (p. 94).
- To adjust the volume of camera signals (p. 95).
- To set the auto-power-off period (p. 95).

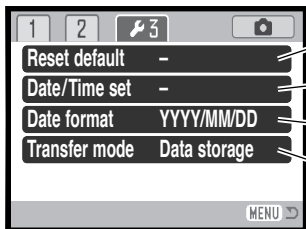

- To reset camera functions (p. 96).
- To set the camera's clock and calendar (p. 22).
- To change the date format (p. 98).
- To select the data transfer mode (p. 98).

LCD MONITOR BRIGHTNESS

The brightness of the LCD monitor can be set in eleven levels. The brightness setting screen is opened from section 1 of the setup menu (p. 90). Use the left/right keys of the controller (1) to adjust the brightness, the monitor image will change accordingly. Press the central button of the controller (2) to set the brightness level.

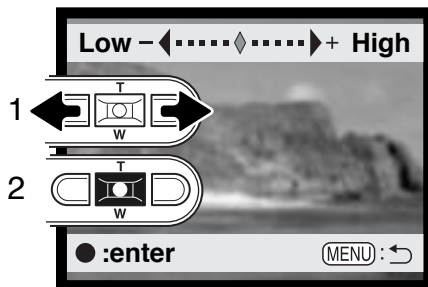

FORMATTING MEMORY CARDS



When a memory card is formatted, all data on the card is erased.

The formatting function is used to erase all data on a memory card. Before formatting a memory card, copy the data to a computer or storage device. Locking images will not protect them from being deleted when the card is formatted. Always format the memory card using the camera; never use a computer to format a card.

When the format option is selected and entered in section 1 of the setup menu (p. 90), a confirmation screen will appear. Choosing “Yes” will format the card, choosing “No” will cancel the formatting operation. A screen will appear to indicate the card has been formatted.

If the unable-to-use-card message appears, the inserted card in the camera may need to be formatted. A memory card used in another camera may also have to be formatted before being used.

FILE NUMBER (#) MEMORY

If file number memory is selected, when a new folder is created, the first file stored in the folder will have a number one greater than the last file saved. If the file number memory is disabled, the image file number will be 0001. File number memory is activated in section 1 of the setup menu.

If file number memory is active and the memory card is changed, the first file saved to the new card will have a number one greater than the last file saved on the previous card if the new card does not contain an image with a greater file number. If it does, the file number of the new image will be one greater than the greatest on the card.

FOLDER NAME

All recorded images are stored in folders on the memory card. Folder names come in two formats, standard and date.

Standard folders have an eight character name. The initial folder is named 100KM002. The first three digits are the folder's serial number, which will increase by one each time a new folder is created. The next two letters refer to Konica Minolta, and the last three numbers indicate the camera used; 002 indicates a DiIMAGE Xg.

A date folder name also starts with the three digit serial number and is followed by one register for the year, two register for the month, and two registers for the day: 101YMMDD. The folder 10140124 was created in 2004 on January 24th.

With the date folder format selected, when an image is recorded a new folder with the day's date will be created. All images recorded that day will be placed in that folder. Images recorded on a different day will be placed in a new folder with the corresponding date. If the file number memory function is off, when a new folder is created, the serial number in the image-file name is reset to 0001. If file number memory function is on, the serial number in the image-file will be one greater than the last image saved. For more information on folder organization and file names, see page 106.



100KM002
(Standard)



10140124
(Date)

LANGUAGE

The language used in the menus can be changed. The language is selected in section 1 of the setup menu.

AUDIO SIGNALS

Every time a button is pressed, an audio signal will give a positive confirmation of the operation. The audio signals can be turned off in section 2 of the setup menu (p. 90). Two audio signals are available. The indicator lamp signals change to match the audio signal changes.

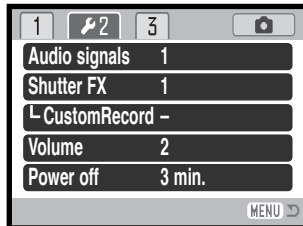

SHUTTER FX

When the shutter is released, a shutter sound effect will give a positive confirmation of the operation. The sound effect can be turned off in section 2 of the setup menu (p. 90). Three shutter effects are available; signal 1 is mechanical, signal 2 is electrical, and custom for a personalized effect. The mechanical shutter sound was taken from the legendary Minolta CLE, a compact rangefinder that represents the pinnacle of the development of the Leitz-Minolta CL.



CUSTOM FX RECORDING

A personalized sound effect can be recorded for the focus signal and shutter release. The camera uses an audio signal to indicate the camera has focused.

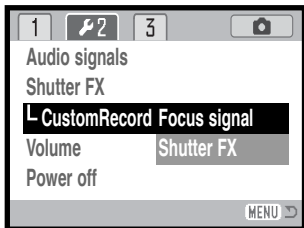

To make a custom recording, select either focus signal or shutter FX from the Cust. FX rec. option on the setup menu. Messages will appear during the routine.

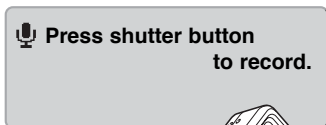

Press the shutter-release button to begin the recording of the shutter sound effect.

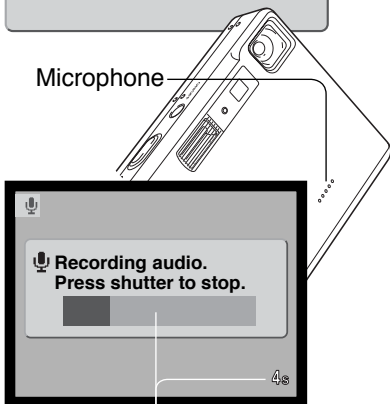

During the recording, hold the camera's microphone approximately 20cm (8 in.) from the audio source. Up to four seconds of audio can be recorded. The remaining recording time is indicated by a status bar and the frame counter on the monitor. The recording will end when the shutter-release button is pressed again or recording time has elapsed.

The length of the recording will affect the performance of the camera. The longer the recorded sound effect, the longer the delay between image capture. This can have a significant affect on the continuous-advance frame rate.

Test custom recording?

To test the recording select and enter “Yes.” During playback, the up/down controller keys control volume and the menu button cancels the playback. Select and enter “Next” to continue.

Save custom recording?

To save the shutter sound effect and replace any previous recording, select and enter “Yes.” “No” will cancel the operation.

Once saved the sound effect can be recalled anytime by selecting the custom setting from the shutter-FX option on the setup menu.

VOLUME

The volume of the audio signals and shutter FX can be increased or decreased in section 2 of the setup menu (p. 90). This affects the camera’s audio signals only and will not change the playback levels of an audio track.

AUTO POWER OFF

To conserve battery power, the camera will shut down if an operation is not made within a certain period. To restore power, press the main switch. The length of the auto-power-off period can be changed in section 2 of the setup menu (p. 90): 1, 3, 5, 10, and 30 minutes. The length of the auto-power-off period is fixed at 10 minutes when the camera is connected to a computer.

RESET DEFAULT

This function affects all modes. When selected, a confirmation screen will appear; choosing “Yes” resets the following functions and settings, “No” cancels the operation.

Focus area	Wide AF focus frames	p. 61
Flash mode	Autoflash	p. 32
Drive mode	Single-frame advance	p. 44
Image size (still)	2048 X 1536	p. 48
Image quality	Standard	p. 48
White balance (still/movie)	Auto	p. 50
Custom key function	Off	p. 51
Camera sensitivity	Auto	p. 52
Metering mode	Multi-segment	p. 53
Exposure compensation	0.0	p. 54
Noise reduction	On	p. 54
Auto reset	On	p. 55
Color mode (still/movie)	Color	p. 56
Voice memo	Off	p. 56
Date imprinting	Off	p. 58
Digital zoom	Off	p. 59
Instant playback	Off	p. 60

Recording mode (Movie/audio menu)	Movie	p. 66
Image size (movie)	320 X 240	p. 66
Frame rate	15 fps	p. 66
Movie mode	Standard movie	p. 66
Date print (DPOF)	Off	p. 85
Image size (E-mail copy)	640 X 480	p. 86
LCD monitor brightness	Normal	p. 91
File number (#) memory	Off	p. 92
Folder name	Standard form	p. 92
Audio signals	1	p. 93
Shutter FX	1 (Custom recording erased)	p. 93
Volume	2	p. 95
Auto-power-off period	3 minutes	p. 95
Transfer mode	Data storage	p. 98

DATE AND TIME

It is important to accurately set the clock. When a recording is made, the date and time of the recording are saved with the file and are displayed in playback mode or with the DiMAGE Viewer software included on the CD-ROM. See page 22 for how to set the date and time.

DATE FORMAT

The date format that is used in monitor displays and for date imprinting can be changed: YYYY/MM/DD (year, month, day), MM/DD/YYYY (month, day, year), DD/MM/YYYY (day, month, year). Simply select the format and enter it by pressing the center controller button; the new format will be displayed on the menu. The date format does not affect date folder names (p. 92). The date format is set in the section 3 of the setup menu (p. 90).

TRANSFER MODE

Three transfer-mode options are available:

Data storage - to transfer data between the camera and computer. This option must be selected when moving image files to the computer, or using the camera with the DiMAGE Viewer software.

Remote camera - allows the live video feed from the camera to be seen on a computer.

PictBridge - to print images with a PictBridge compatible printer.

For more on these options, refer to the data-transfer section of the manual.

DATA-TRANSFER MODE

Read this section carefully before connecting the camera to a computer. Details on using and installing the DiMAGE Viewer software are found in the supplied software manual. The DiMAGE manuals do not cover the basic operation of computers or their operating systems; please refer to the manual supplied with your computer.

SYSTEM REQUIREMENTS

For the camera to be connected directly to the computer and used as a mass-storage device, the computer must be equipped with a USB port as a standard interface. The computer and the operating system must be guaranteed by their manufacturers to support USB interface. The following operating systems are compatible with the camera:

IBM PC/AT Compatible	Macintosh
Windows®98, 98SE, Me, 2000 Professional, and XP (Home/Professional)	Mac OS 9.0 - 9.2.2, Mac OS X v.10.1.3 - 10.1.5, v.10.2.1 - 10.2.8, and v.10.3 - 10.3.1

Check the Konica Minolta web site for the latest compatibility information:

North America: <http://www.konicaminolta.us/>

Europe: <http://www.konicaminoltasupport.com/>

Users with Windows®98 or 98 Second Edition will need to install the driver software on the included DiMAGE Viewer CD-ROM (p. 102). No special driver software is required for other Windows® or Macintosh operating systems.

Customers who have bought a previous DiMAGE digital camera and have installed the Windows®98 driver software must repeat the installation procedure. The updated version of the driver software included on the supplied DiMAGE Viewer CD-ROM is required for the operation of the DiMAGE Xg with a computer. The new software will have no effect on the performance of older DiMAGE cameras.

CONNECTING THE CAMERA TO A COMPUTER

A fully charged battery should be used when the camera is connected to a computer. The use of the AC adapter set (sold separately) is recommended over the use of the battery. For users with Windows®98 or 98SE, read the section on page 102 on how to install the necessary USB driver before connecting the camera to a computer.

1. Start up the computer. The computer must be turned on before connecting the camera.
2. Insert the memory card into the camera. To change the memory card while the camera is connected to a computer, see page 108.
3. Slide the USB-port cover open. Insert the small plug of the USB cable into the camera. Make sure the plug is firmly attached.

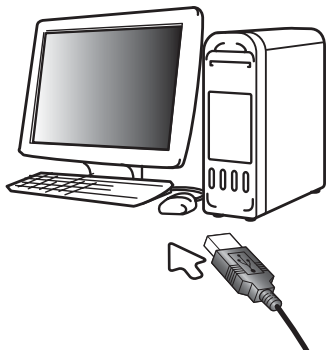
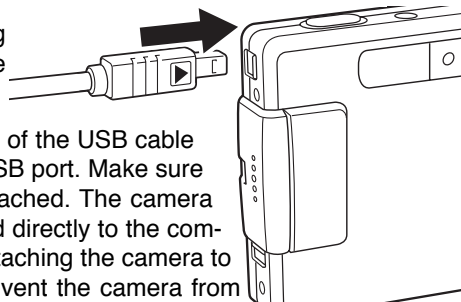

4. Attach the other end of the USB cable to the computer's USB port. Make sure the plug is firmly attached. The camera should be connected directly to the computer's USB port. Attaching the camera to a USB hub may prevent the camera from operating properly.

- 5 Turn on the camera to initiate the USB connection. While the camera is connected to a computer, the data-transfer screen will be displayed.

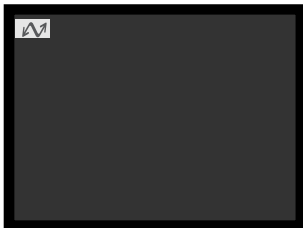



Windows®XP

When the USB connection is completed, a drive icon, or volume, will appear in My Computer or on the desktop; the name varies with memory card. When using Windows®XP or Mac OS X, a window will open requesting instructions on what to do with the image data; follow the directions in the window. If the computer does not recognize the camera, disconnect the camera and restart the computer. Repeat the connection procedure above.



Mac OS X



Windows®

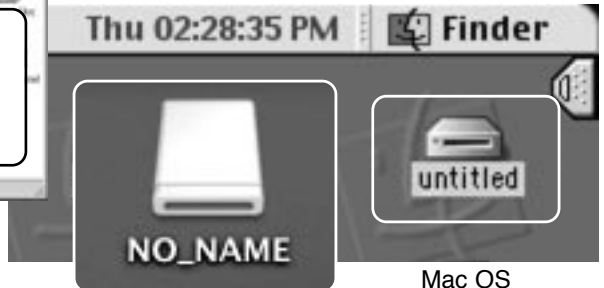

Mac OS X

Mac OS

The volume name varies between memory cards.

CONNECTING TO WINDOWS 98 AND 98SE

The driver needs only to be installed once. If the driver cannot be installed automatically, it can be installed manually with the operating system's add-new-hardware wizard; see the instructions on the following page. During installation, if the operating system requests the Windows®98 CD-ROM, insert it into the CD-ROM drive and follow the accompanying instructions on the screen. No special driver software is required for other Windows operating systems.

Automatic Installation



Before connecting the camera to the computer, place the DiMAGE Viewer CD-ROM in the CD-ROM drive. The DiMAGE installer menu should automatically activate. To automatically install the Windows®98 USB driver, click on the **“Starting up the USB device driver installer”** button. A window will appear to confirm that the driver should be installed; click “Yes” to continue.



When the driver has been successfully installed, a window will appear. Click “OK.” Restart the computer before connecting the camera (p. 100).

Manual installation

To install the Windows 98 driver manually, follow the instructions in the connecting-the-camera-to-a-computer section on page 100.

When the camera is plugged into the computer, the operating system will detect the new device and the add-new-hardware-wizard window will open. Place the DiIMAGE Viewer CD-ROM in the CD-ROM drive. Click “Next.”



Choose the recommended search for a suitable driver. Click “Next.”

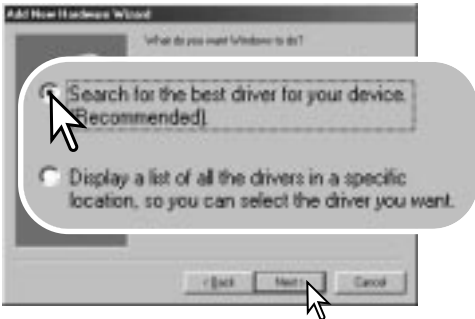

Choose to specify the location of the driver. The browse window can be used to indicate the driver location. The driver should be located in the CD-ROM drive at :\\Win98\\USB. When the location is shown in the window, click “Next.”





The add new hardware wizard will confirm the location of the driver. One of three drivers may be located: MNLVENUM.inf, USBPDR.inf, or USBSTRG.inf. The letter designating the CD-ROM drive will vary between computers. Click “Next” to install the driver in the system.

The last window will confirm the driver has been installed. Click “Finish” to close the add new hardware wizard. Restart the computer.

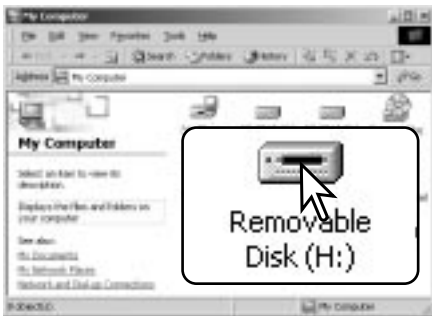

When the my-computer window is opened, a new removable-disk icon will be displayed. Double click on the icon to access the camera’s memory card; see page 106.

AUTO POWER OFF - DATA-TRANSFER MODE

If the camera does not receive a read or write command within ten minutes, it will shut down to save power. When the camera shuts down, an unsafe-removal-of-device warning may appear on the computer monitor. Click “OK.” Neither the camera or computer will be damaged in this operation. Unplug the USB cable and turn off the camera. Remake the USB connection by reattaching the cable and turning the camera on.

QUICKTIME 6 SYSTEM REQUIREMENTS

IBM PC/AT Compatible

A Pentium processor-based PC or compatible computer

Windows®98, 98SE, Me, 2000 Professional, and XP (Home/Professional)

At least 128MB of RAM

To install QuickTime, follow the instructions in the installer. The latest version of QuickTime can be downloaded free of charge from the Apple Computer web site: <http://www.apple.com/>.

MEMORY CARD FOLDER ORGANIZATION



Drive Icon

Once the camera is connected to the computer, image and audio files can be accessed by double clicking on icons. Image folders are located in the DCIM folder. To copying images and audio recordings, simply drag and drop the file icon into a location in the computer.



Dcim



Misc

The misc. folder contains DPOF print files (p. 84).

Files and folders on the memory card can be deleted using the computer. Never format the memory card from the computer; always use the camera to format the card. Only files recorded by the camera should be stored on the memory card.



100KM002



10140124



102KM_EM



PICT0001.JPG
Fine, standard, or economy image



PICT0001.WAV
PICT0001's voice-memo or audio-caption file



PICT0002.MOV
Movie clip



PICT0003.WAV
Audio recording

Image and audio file names begin with “PICT” followed by a four-digit file number and a jpg, or mov extension. Voice-memo and audio-caption files have a wav extension and the file name corresponds to their image file. Audio recordings also use the wav extension. To copying images, simply drag and drop the file icon into a location in the computer.

E-mail Copy images are placed in a folder ending in “EM.” When a new folder is created, the first three digits in the folder name will be one greater than the largest folder number on the card. When the index number in the image file name exceeds 9,999, a new folder will be created with a number one greater than the greatest folder number on the memory card: e.g. from 100KM002 to 101KM002.

The number in the image file name may not correspond to the frame number of the image. As images are deleted in the camera, the frame counter will adjust itself to show the number of images on the card and reassign the frame numbers accordingly. The serial numbers used with image files will not change when an image is deleted. When a new image is recorded, it will be assigned a number one greater than the largest serial number in the folder. File serial numbers can be controlled with the file-number-memory function in section 1 of the setup menu (p. 92).

Camera Notes

Image files contain exif tag data. This data includes the time and date the image was recorded as well as the camera settings used. This data can be viewed with the camera or the DiIMAGE Viewer software. If a camera image is opened in a image-processing application that does not support Exif tags, and then the image is saved overwriting the original data, the exif tag information is erased. Some Exif compatible applications rewrite the Exif data preventing the DiIMAGE Viewer from reading it. When using software other than the DiIMAGE Viewer, always make a backup copy of the image files to protect the exif tag data.

To view images correctly on your computer, the monitor’s color space may need to be adjusted. Refer to your computer manual on how to calibrate the display to the following requirements: sRGB, with a color temperature of 6500K, and a gamma of 2.2. Changes made to the captured image with the camera’s contrast and color-saturation controls will affect any color-matching software in use.

DISCONNECTING THE CAMERA FROM A COMPUTER



Never disconnect the camera when the access lamp is red - the data or memory card may permanently be damaged.

Windows®XP, 2000 Professional, and Me



To disconnect the camera, click once on the unplug-or-eject-hardware icon located on the task bar. A small window will open indicating the device to be stopped.



Click on the small window to stop the device. The safe-to-remove-hardware window will open. Click on "OK" to close the window, turn the camera off, and then disconnect the USB cable.



When more than one external device are connected to the computer, repeat the procedure above except right click on the unplug-or-eject-hardware icon. This will open the unplug-or-eject-hardware window after clicking on the small window indicating the unplug-or-eject-hardware routine.



The hardware devices to be stopped will be displayed. Highlight the device by clicking on it then click “Stop.”

A confirmation screen will appear to indicate the devices to be stopped. Clicking “OK” will stop the device.

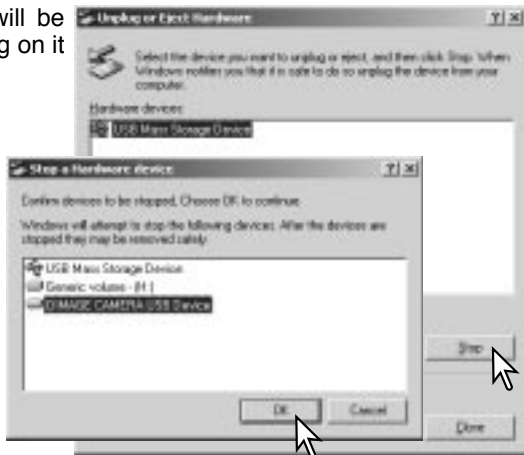

A third and final screen will appear to indicate the camera can be safely disconnected from the computer. Close the window, turn the camera off, and then disconnect the USB cable.

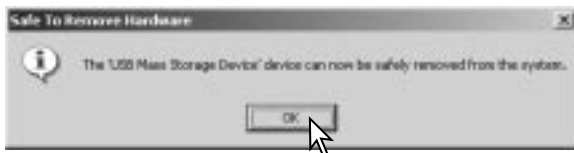

Windows®98 / 98 Second Edition

Confirm that the access lamp is not lit. Turn the camera off, and then disconnect the USB cable.

Macintosh

Confirm that the access lamp is not lit and then drag the mass-storage device icon and drop it into the trash. Turn the camera off, and then disconnect the USB cable.



CHANGING THE MEMORY CARD - DATA-TRANSFER MODE



Never remove the card when the access lamp is red - the data or memory card may permanently be damaged.

Windows®XP, 2000 Professional, and Me

1. Stop the USB connection using the unplug-or-eject-hardware routine (p. 108).
2. Turn off the camera.
3. Change the memory card.
4. Turn on the camera to remake the USB connection.

Windows®98 and 98 Second Edition

1. Turn off the camera.
2. Change the memory card.
3. Turn on the camera to remake the USB connection.

Macintosh

1. Stop the USB connection by dragging the drive icon into the trash (p. 109).
2. Turn off the camera.
3. Change the memory card.
4. Turn on the camera to remake the USB connection.

USING PictBridge COMPATIBLE PRINTER

Connecting the camera to a PictBridge compatible printer allows still images to be printed directly. To print images with a PictBridge compatible printer, the transfer-mode option in section 3 of the setup menu must be set to “PictBridge” (p. 98).

Before each print run, check the printer settings; refer to the manual that was supplied with the printer. A fully charged battery should be used when the camera is connected to the printer. The use of the AC adapter set (sold separately) is recommended over the use of the battery.

Connect the camera to a PictBridge compatible printer using the camera's USB cable. The larger plug on the cable is connected to the printer. Slide open the USB-port cover and insert the smaller plug of the cable into the camera. Turn the camera on; the PictBridge screen will be displayed automatically.

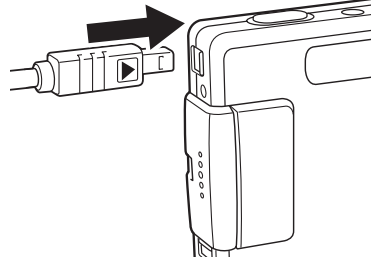

SELECTING PRINT IMAGES

Individual still images can be selected for printing on the PictBridge screen. For other printing options, see the menu navigation section (p. 113).

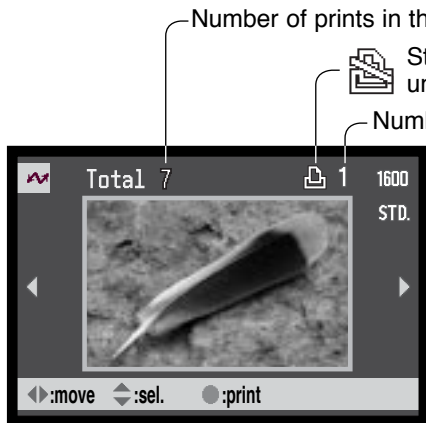

Number of prints in the print run.



Strike through indicates unprintable file type.

Number of copies of the displayed image.

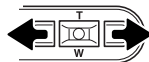

Use the left/right keys of the controller to display the image to be printed.



Press the up key to select the number of copies to be printed. To deselect an image for printing, press the down key until the number of copies reaches zero.

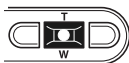

Repeat the previous steps until all the images to be printed are selected. Press the central button of the controller to continue.

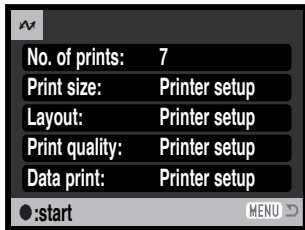

The number of prints in the print run are displayed as well as the print parameters selected with the menu. See the menu navigation section for more information. Press the central button of the controller to begin printing, or press the menu button to return to the PictBridge screen.

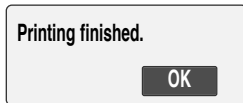

Once printing begins, the operation can be canceled by pressing the center of the controller. The printing-finished message indicates the end of the operation; turn the camera off to end the routine.

The display button switches between the single frame and index playback formats on the PictBridge screen.

NAVIGATING THE PictBridge MENU

Navigating the menu is simple. The menu button turns the menu on and off. The left/right and up/down keys of the controller control the cursor and change settings on the menu. Pressing the center button of the controller selects menu options and sets adjustments.

MENU



To activate the PictBridge menu, press the menu button.

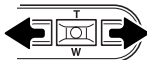

Use the left/right keys to highlight the appropriate menu tab; the menus will change as the tabs are highlighted.



Use the up/down key to scroll through the menu options. Highlight the option whose setting needs to be changed.

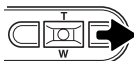

With the menu option highlighted, press the right key; the settings will be displayed with the current setting highlighted. If "Start" is displayed, press the center button of the controller to continue.



Use the zoom lever to highlight the new setting.

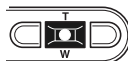

Press the center button of the controller to select the highlighted setting.

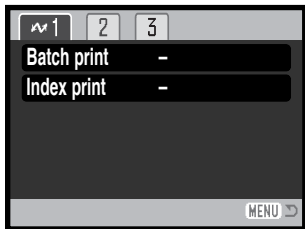

Once a setting has been selected, the cursor will return to the menu options and the new setting will be displayed. To return to the PictBridge screen, press the menu button. Read the following sections on information on the menu options.

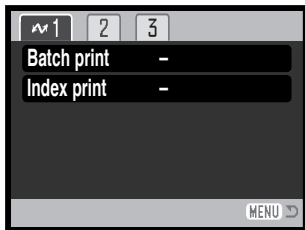

The options that can be changed vary with the printer.

Batch print

Batch print in section 1 selects all still images on the memory card for printing. When the all-frames option is selected, a screen opens so the number of copies of each image can be specified. The reset option cancels all changes made to the print-selection screen.

Index print

An index print of all still images on the memory card can be made. The quality and size of the print can be specified with the camera menu. The number of images per page varies with the printer. The print-setup confirmation screen is displayed before the print routine starts.

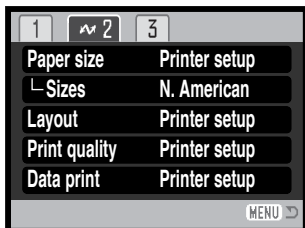

Paper size

The paper size of the print can be specified. The printer-setup option uses the size set with the printer. The sizes option should be set first, see below.

Sizes

To set paper sizes depending on region. This changes the paper-size option to common sizes used in particular areas.

Layout

The layout of the print can be set. The printer-setup option uses the layout parameters of the printer. Borderless printing can be specified with the camera as well as the number of images per page.

Print quality

The print quality can be set. The printer-setup option uses the quality set with the printer. The fine quality can be specified with the camera.

Data print

Data can be printed with the image. The printer-setup option uses the options set with the printer. The date of capture and the file name can be selected for printing. Data printing can also be disabled with the menu.

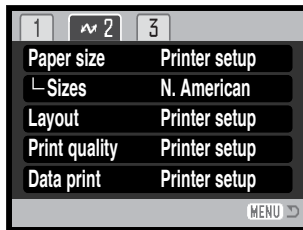

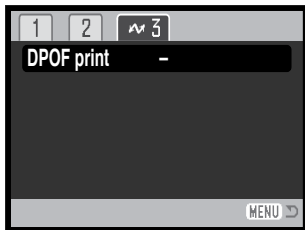

DPOF print

DPOF print in section 3 allows still images and an index print selected with the DPOF printing options in section 3 of the playback menu to be printed from a DPOF compatible PictBridge printer. Simply select the start option from the menu to begin the routine. The transfer-mode option in section 3 of the setup menu must be set to “Data storage” to use DPOF print.

Printing Notes

The following are the dimensions for postcard, L, and 2L paper sizes in both millimeters and inches for your reference:

Postcard	100 X 148mm	3.9 X 5.9 in.
L	89 X 127mm	3.5 X 5.0 in.
2L	127 X 178mm	5.0 X 7.0 in.

NOTES ON PRINTING ERRORS

If a minor problem occurs during printing, such as the paper runs out, follow the procedure recommended for the printer; no action is required for the camera. If a major printer error occurs, press the center of the controller to end the routine. Refer to the printer manual for the correct procedure for the printer problem. Check the printer settings before starting again and deselect the images that were printed.

REMOTE CAMERA SYSTEM REQUIREMENTS

For the camera to be connected directly to the computer and used as a remote imaging device, the computer must be equipped with a USB port as a standard interface. The computer and the operating system must be guaranteed by their manufacturers to support USB interface. See chart for system requirements.

The remote-camera driver software must be installed. Specific application software, such as Microsoft Net Meeting, is required to view the images. This function cannot be used with Macintosh computers.

Minimum system requirements

Pentium II 300MHz or later

Windows®XP, 2000 Professional, Me, and 98 Second Edition

128MB of RAM. 256MB with Windows®XP.

200MB of hard-disk space

800 X 600 16-bit color monitor

Remote camera tested with Microsoft Net Meeting and Windows Messenger

INSTALLING THE REMOTE CAMERA DRIVER

The driver needs only to be installed once. This driver is not compatible with Macintosh operating systems.

Before connecting the camera to the computer, place the DiIMAGE Viewer CD-ROM in the CD-ROM drive. The DiIMAGE installer menu should automatically activate. To install the driver, click on the **“Starting up the DiIMAGE remote camera driver installer”** button.





The InstallShield Wizard window is displayed. Click the “Next >” button to continue.



The license agreement is displayed. If you accept the agreement, click the “Yes” button to continue.

Read the entire agreement carefully before continuing. If you do not agree to the terms, click the “No” button to exit the installation program.



An installation confirmation screen appears. To install the remote camera driver, click “Yes.’ The “No” button will cancel the operation without installing the driver.



When the driver installation has been completed, a message will be displayed. Click the “Finish” button to complete the operation.

CONNECTING THE REMOTE CAMERA

Before the camera can be connected to a computer, the remote camera driver must be installed, see page 118. A fully charged battery should be used when the camera is connected to a computer. The use of the AC adapter set (sold separately) is recommended over the use of the battery. For users with Windows 98SE, the USB driver must be installed before connecting the camera to a computer (p. 102).

1. Select Remote Camera from the transfer mode option in section 3 of the setup menu.
2. Start up the computer. The computer must be turned on before connecting the camera.

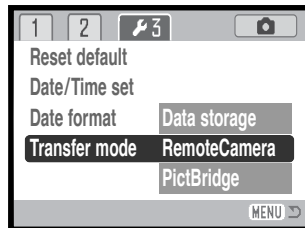

3. Slide the USB-port cover open. Insert the small plug of the USB cable into the camera. Make sure the plug is firmly attached.
4. Attach the other end of the USB cable to the computer's USB port. Make sure the plug is firmly attached. The camera should be connected directly to the computer's USB port. Attaching the camera to a USB hub may prevent the camera from operating properly.
- 5 Turn on the camera to initiate the USB connection. A live image is displayed on the monitor.

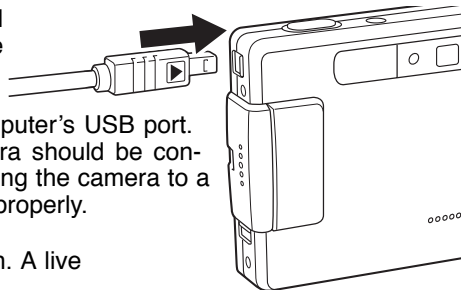

To view the live image on the computer, follow the instructions for the application used. Refer to the application's instruction manual or help section for details.

NOTES ON REMOTE CAMERA OPERATION

When using the remote camera, exposure, white balance, and camera sensitivity are set to auto. The optical and 4X digital zoom are active. There are no menu controls. The monitor cannot be turned off. The flash is disabled. There is no audio.

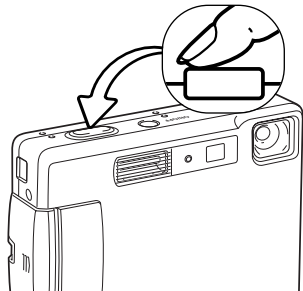

The camera can be focused periodically by pressing the shutter-release button partway down. The AF system does not continually focus when the button is pressed and held so the operation should be repeated as the subject distances changes.

Because of the data rate, there may be delays when the camera is focused or zoomed.

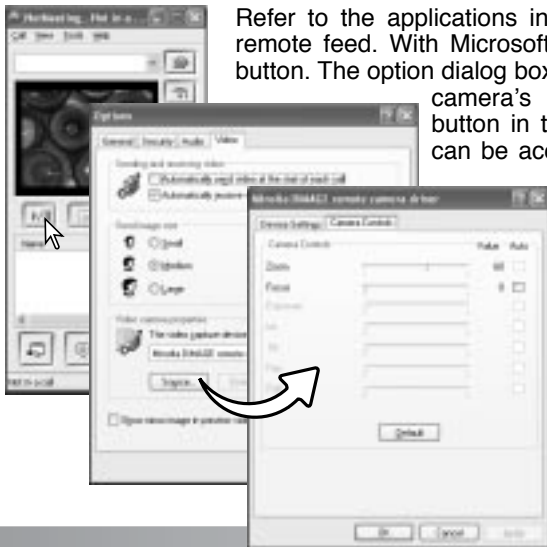

Refer to the applications instruction manual on how to view the remote feed. With Microsoft Net Meeting, simply click on the play button. The option dialog box allows remote control over some of the camera's functions. By clicking on the source button in the video tab, zoom and focus controls can be accessed; the controls are located on the camera control tab of the dialog box. Image magnification can be adjusted with the zoom slider. Clicking the auto check box on the focus option focuses the camera. However, focus is not continuous and the box must be checked each time focusing is required.

APPENDIX

Troubleshooting

The section covers minor problems with basic camera operation. For major problems or damage, or if a problem continues to reoccur frequently, contact our service facility.

Problem	Symptom	Cause	Solution
The camera will not work.	Nothing displayed on the monitor.	The battery is dead.	Replace battery (p. 14).
		The auto-power-off function has turned the camera off.	Press the main switch to restore power. The length of the auto-power-off period can be changed in section 1 of the setup menu.
		The AC adapter set is not connected properly.	Check that the AC adapter set is connected to the camera and a live electrical outlet (p. 17, 18).
Shutter will not release.	"0000" is displayed on the frame counter.	Memory card is full and unable to store an image at the image-quality or image-size setting on the camera.	Insert a new memory card (p. 20), delete some images (p. 37), or change the image-quality or image-size setting (p. 48).
	No-card warning appears on the monitors.	No memory card in the camera.	Insert a memory card (p. 20).
	Card-locked warning appears on the monitor.	Memory card is locked.	Unlock the memory card using the write-protect switch (p. 21).

Problem	Symptom	Cause	Solution
Pictures are not sharp.	Focus signal is red.	Subject is too close.	Make sure the subject is within the autofocus range (p. 30).
		A special situation is preventing the autofocus system from focusing (p. 31).	Use the focus-lock function to focus on an object at the same distance as the subject (p. 30).
	Pictures are taken indoors or in low-light situations without flash.	Slow shutter speeds result in blurred images when the camera is hand-held.	Use a tripod, change the camera sensitivity to a higher setting (p. 52), or use the flash (p. 32).
While using flash, the pictures are too dark.	The subject is beyond the flash range (p. 33).		Move closer to the subject or change the camera sensitivity to a higher setting (p. 52).
Subject appears too far to the right in the image.	Viewfinder was used for framing. Parallax is apparent with subjects closer than 1m (3ft.) at the zoom's wide-angle position or 3m (10ft) at the telephoto position.		Only use the LCD monitor for framing with close subjects.
Part of the image area is hidden behind a dark object.	Viewfinder was used to capture the image.	The lens was partially covered with an object or finger.	When using the viewfinder, take care not to cover the lens.

If the camera does not function normally, turn it off, remove and reinsert the battery, or unplug and reconnect the AC adapter set. Always turn the camera off using the main switch otherwise the memory card may be damaged and camera settings reset.

ABOUT THE LITHIUM-ION BATTERY CHARGER CORD

The included AC cord is designed for the current of the sales region. Only use the cord in the region it was purchased.

Region	Product code
Continental Europe, China, Korea, Singapore (220-230V)	APC-110
Great Britain, Hong Kong (220V-240V)	APC-120
United States, Canada, Taiwan (110V-120V)	APC-130
Japan (100V)	APC-140

VIEWFINDER INDICATOR LAMPS

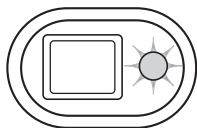

The indicator lamp next to the viewfinder can be used to diagnose camera operations. The lamp colors change between green, red, and orange, and the lamp can glow steadily or blink at two rates.

Color	Status	Indication
Green	Steady	Camera ready to take an image.
	Blinking slowly	Camera-shake warning - shutter speed is below the limit where the camera can be safely hand-held. Use flash (p. 32) or tripod.
	Blinking quickly	The camera cannot focus. The subject is closer than 0.15 m (0.5ft.) or a special situation is preventing the autofocus system from focusing (p. 31).
Red	Blinking quickly	Power is insufficient for camera operation. The flash is charging (the shutter cannot be released). The memory card is locked. The memory card is full. The memory card cannot be used with the camera and may need to be formatted.
Orange	Blinking quickly	The camera is accessing the memory card.

REMOVING THE DRIVER SOFTWARE - WINDOWS

- 1. Insert a memory card in the camera and connect it to the computer with the USB cable. Other devices must not be connected to the computer during this procedure.*
- 2. Right click on the My-computer icon. Select “properties” from the drop-down menu.
Windows®XP: from the start menu go to the control panel. Click on the performance and maintenance category. Click “System” to open the system properties window.*
- 3. Windows®XP and 2000 Professional: select the hardware tab in the properties window and click the device-manager button.
Windows®Me and 98: click the device-manager tab in the properties window.*
- 4. The driver file will be located in the universal-serial-bus-controller or other-devices location of the device manager. Click on the locations to display the files. The driver should be indicated with the camera name. Under certain conditions, the driver name may not contain the camera name. However, the driver will be indicated by either a question mark or exclamation point.*
- 5. Click on the driver to select it.*
- 6. Windows®XP and 2000 Professional: click on the action button to display the drop-down menu. Select “uninstall.” A confirmation screen will appear. Clicking “Yes” will remove the driver from the system.
Windows®Me and 98: click the remove button. A confirmation screen will appear. Clicking “Yes” will remove the driver from the system.*
- 7. Disconnect the USB cable and turn off the camera. Restart the computer.*

CARE AND STORAGE

Read this section in its entirety to get the best results from your camera. With proper care, your camera will provide years of service.

Camera care

- Do not subject the camera to shock or impact.
- Turn off the camera when transporting.
- This camera is neither waterproof nor splashproof. Inserting or removing batteries or the memory card, or operating the camera with wet hands may damage the camera.
- When at the beach or near water, take care not to expose the camera to water or sand. Water, sand, dust, or salt can damage the camera.
- Do not leave the camera under direct sunlight. Do not point the lens directly at the sun; the CCD may be damaged.

Cleaning

- If the camera or the outside of the lens is dirty, gently wipe it with a soft, clean, dry cloth. If the camera or lens comes in contact with sand, gently blow away loose particles. Wiping may scratch the surface.
- To clean the lens surface, first blow away any dust or sand, then gently wipe the lens with a cloth or tissue designed for optics. Use lens-cleaning fluid if necessary.
- Never use organic solvents to clean the camera.
- Never touch the lens surface with your fingers.

Storage

- Store in a cool, dry, well-ventilated area away from dust and chemicals. For long periods of disuse, store the camera in an airtight container with a silica-gel drying agent.
- Remove the batteries and memory card from the camera when not in use for extended periods.
- Do not store the camera in an area with naphthalene or mothballs.
- During long periods of storage, operate the camera occasionally. When taking the camera out of storage, check that the camera is functioning properly before using.

Memory cards

SD Memory Cards and MultiMediaCards are manufactured with precision electronic components. The following may cause data loss or damage:

- Improper use of the card.
- Bending, dropping, or subjecting the card to impact.
- Heat, moisture, and direct sunlight.
- Static electrical discharge or electromagnetic fields near the card.
- Removing the card or interrupting the power supply while the camera or a computer is accessing the card (reading, writing, formatting, etc.).
- Touching the electrical contacts of the card with your fingers or metal objects.
- Using the card beyond its life. Purchasing a new card periodically may be necessary.

Minolta has no responsibility for any loss or damage to data. It is recommended that a copy of the card data be made.

Batteries

- Battery performance decreases with temperature. In cold environments, we recommend keeping spare batteries in a warm place, such as the inside of a coat. Batteries can recover their power when they warm up.
- Do not store the battery when it is fully charged.
- When storing the battery for extended periods, recharge it for five minutes every six months. The battery may not be able to be charged if completely exhausted.
- A special built-in, long-life battery supplies power to the clock and memory when the camera is turned off. If the camera resets each time it is turned off, the battery is exhausted. It must be replaced at a Minolta service facility.
- Keep battery and camera charger contacts clean. Dirty contacts can prevent charging. If the contacts become dirty, wipe them with a cotton swab.

Before important events and journeys

- Check the camera's operation; take test pictures and purchase spare batteries.
- Minolta has no responsibility for any damage or loss incurred by equipment malfunction.

Operating temperatures and conditions

- This camera has been designed for use in temperatures from 0°C to 40°C (32°F to 104°F).
- Never leave the camera exposed to extreme high temperatures, such as in a car parked in the sun, or to extreme humidity.
- When taking the camera from a cold to a warm environment, place it in a sealed plastic bag to prevent condensation from forming. Allow the camera to come to room temperature before removing it from the bag.

LCD monitor care

- The LCD monitor is manufactured using high-precision technology and more than 99.99% of the pixels operate properly. Less than 0.01% of the monitor pixels are displayed as color or bright points; this is not a monitor defect and does not affect the recorded image.
- Do not apply pressure to the surface of the LCD monitor; it may be permanently damaged.
- In cold temperatures, the LCD monitor may become temporarily dark. When the camera warms up, the display will function normally.
- The LCD monitor may be slow to react in low temperatures or may turn dark in a hot environment. When the camera reaches normal operating temperature, the display will function normally.
- If fingerprints are on the LCD monitor surface, gently wipe with a soft, clean, dry cloth.

Copyright

- TV program, films, video tapes, photographs, and other materials may be copyrighted. Unauthorized recording or duplication of such material may be contrary to copyright laws. Taking pictures or images of performances, exhibitions, etc., is prohibited without approval and can infringe on copyright. Images protected by copyright can only be used under the provisions within the copyright laws.

Questions and service

- If you have questions about your camera, contact your local camera dealer or write to the Konica Minolta distributor in your area.
- Before shipping your camera for repair, please contact a Konica Minolta service facility.

TECHNICAL SPECIFICATIONS

Number of effective pixels:	3.2 million
CCD:	1/2.7-type interline complementary-color CCD with a total of 3.3 million pixels.
Camera sensitivity (ISO):	Automatic (between ISO 50 - 160 equivalent), ISO 50, 100, 200, 400
Aspect ratio:	4:3
Lens construction:	9 elements in 8 groups.
Maximum aperture:	f/2.8 - f/3.6
Focal length:	5.7 - 17.1 mm (35mm equivalent: 37 - 111 mm)
Focusing range:	0.15 m - infinity (from the front of the camera)
Autofocusing system:	Video AF
Shutter:	CCD electronic shutter plus mechanical shutter
Shutter speeds:	4 - 1/1000s
Built-in flash recycling time:	Approximately 6 seconds
Viewfinder:	Optical real-image zoom viewfinder.
Monitor LCD:	4.0 cm TFT color
Monitor field of view:	Approximately 100%
A/D conversion:	10 bits
Recording media:	SD Memory Cards and MultiMediaCards
File formats:	JPEG, motion JPEG (MOV), WAV. DCF 1.0, DPOF, and Exif 2.2 compliant.
Print Image Matching II:	Yes
Menu languages:	Japanese, English, German, French, and Spanish
Battery:	Minolta NP-200 lithium-ion battery.
Battery performance (recording):	Approximately 220 frames: based on CIPA's standard: NP-200 lithium-ion battery, SD memory card included in the product package, LCD monitor on, 2048 X 1536 image size, standard image quality, no instant playback, no voice memo, flash used with 50% of the frames.

CIPA: Camera & Imaging Products Association

Approximately 500 frames: NP-200 lithium-ion battery, SD memory card included in the product package, LCD monitor off, 2048 X 1536 image size, standard image quality, no instant playback, no voice memo, flash used with 50% of the frames.

Battery performance (playback): Approximate continuous playback time: 240 min.
: NP-200 lithium-ion battery, LCD monitor on, no audio playback.

External power source: AC adapter set AC-401/501

Dimensions: 85.5 (W) X 67 (H) X 20 (D) mm

Weight: Approximately 120g
(without battery or recording media)

Operating temperature: 0° - 40°C

Operating humidity: 5 - 85% (noncondensing)

Lithium-ion Battery NP-200

Voltage: 3.7V

Weight: 20g

Dimensions 31.5 (W) X 52.0 (H) X 6.5 (D) mm

Battery Charger BC-700

Input voltage: AC100-240V, 50/60Hz

Weight: 79g

Dimensions 65 (W) X 80 (H) X 26 (D) mm

Specifications are based on the latest information available at the time of printing and are subject to change without notice.



KONICA MINOLTA

KONICA MINOLTA CAMERA, INC.

© 2003 Konica Minolta Camera, Inc. under the Berne Convention
and the Universal Copyright Convention.

0-43325-53285-6

1AG6P1P1795--
9222-2798-11 SY-A312
Printed in Japan